

BARBER
LINE
Industrias Oriol

**Especial
Barbería
Special
Barbershop**

Sin precio / Without prices



EUROSTIL
PROFESSIONAL

RAGNAR
BARBER LINE



FEATHER®

MUSOL

DERBY®



ELIOS

pen RAZOR® by MAGIA

CLIPP-AID

BERGMANN

01 Eléctricos Electrics 4

Máquinas corte RAGNAR · RAGNAR hair clippers	5
Máquinas corte CAPTAIN COOK · CAPTAIN COOK hair clippers	12
Máquinas corte y retoque EUROSTIL · EUROSTIL retouch and hair clippers	14
Máquinas retoque RAGNAR · RAGNAR retouch hair clippers	16
Máquinas retoque CAPTAIN COOK · CAPTAIN COOK retouch hair clippers	17
Máquinas retoque RAGNAR 360° · RAGNAR retouching 360° hair clippers	20
Máquinas retoque CAPTAIN COOK 360° · CAPTAIN COOK retouching 360° hair clippers	21
Afeitadora RAGNAR, BARBER LINE y CAPTAIN COOK · RAGNAR, BARBER LINE and CAPTAIN COOK hair clippers	22
Nariceros · Nose hair clippers	25
Accesorios máquinas corte (aceites) · Hair clippers accessories (oils)	26
Secadores, planchas y fusores · Hair dryers, hair straighteners and wax heaters	28
Aspirador de cabello · Hair vacuum	32
Esterilizadores · Sterilizers	33

02 Navajas y cuchillas Razors & blades 36

Navajas RAGNAR · RAGNAR razors	37
Navajas BARBER LINE · BARBER LINE razors	39
Navajas CAPTAIN COOK · CAPTAIN COOK razors	43
Navajas EUROSTIL · EUROSTIL razors	45
Navajas FEATHER y sus cuchillas · FEATHER razors and blades	46
Cuchillas · Razors	47
Navajas desechables · Disposable razors	48
Pen razor, espumas y geles · Pen razor, shaving foam and shaving gel	51

03 Tijeras Scissors 52

Tijeras RAGNAR · RAGNAR scissors	53
Tijeras CAPTAIN COOK · CAPTAIN COOK scissors	56
Tijeras BARBER LINE · BARBER LINE scissors	59
Tijeras EUROSTIL · EUROSTIL scissors	60
Tijeras iniciación · Initiation scissors	62
Tijeras especial zurdos · Left handed scissors	63

04 Cepillos y brochas Barber & shaving brushes 64

Cepillos y Brochas · Barber brush & brushes	65
Talco · Talc	67
Cepillos BARBER LINE y RAGNAR · BARBER LINE and RAGNAR brushes	68
Cepillos EUROSTIL · EUROSTIL brushes	72
Cepillos CAPTAIN COOK · CAPTAIN COOK brushes	73

05 Peines Combs 74

Peines RAGNAR · RAGNAR combs	75
Peines CAPTAIN COOK · CAPTAIN COOK combs	79
Peines BARBER LINE · BARBER LINE combs	81
Peines EUROSTIL · EUROSTIL combs	82
Peines Carbono · Carbon combs	83
Peines SILKOMB · SILKOMB combs	84
Peine niveles y limpiador de peines · Level cutting comb and cleaning combs	85

06 Cosmética Cosmetics 86

RAGNAR	87
CAPTAIN COOK	88
THE SHAVING CO	95
MR. BEAR FAMILY	99
OSMA	101
MYRSOL	102
LEGEND	106
TASSEL	107

07 Mobiliario y decoración Furniture & decoration 110

Polo barbero · Barber pole	111
Sillón barbero · Barber armchair	112
Lavacabezas · Wash basin chair	117
Sillas niños · Children's seats	119
Espejos · Mirrors	121
Carritos y bidón · Trolleys and can	122
Mostradores recepción y otros · Reception desks and others	123

08 Accesorios Accessories 128

Papel cuello · Neck paper	129
Capas · Capes	132
Vestuario masculino LACLA · LACLA men's clothing	138
Pulverizadores · Sprayers	142
Maletas · Suitcases	146
Toallas · Towels	148
Guantes y accesorios · Gloves and accessories	150
Desinfectante, esterilizadores, espejos y escobas · Disinfectant, sterilizers, mirrors and brooms	153

09 Formación Training 160

Cabezas maniquí EUROSTIL · EUROSTIL mannequin head	161
Cabezas maniquí BARBERLINE · BARBER LINE mannequin head	162
Soportes y trípodes · Supports and tripods	163

Los precios que figuran en este catálogo son precios recomendados, impuestos no incluidos.
Los precios serán vigentes salvo errores tipográficos.
Industrias Oriol 1942, S.L. se reserva el derecho a realizar modificaciones sin previo aviso.

*The prices in the catalog are intended for professionals and do not include VAT.
Prices are up to date unless there is a typographical error.
Industrias Oriol 1942 S.L. reserves the right to make changes without notice.*

THUNDER MÁQUINA CORTE RECARGABLE

Máquina de corte recargable THUNDER de "Captain Cook", diseñada para el uso del profesional. Motor potente y de larga duración, súper silencioso y de baja vibración. Fabricada con materiales de alta calidad y de última generación.



THUNDER HAIR CLIPPER RECHARGEABLE



01

Eléctricos Electrics

*Máquinas de corte y de retoques, afeitadoras,
secadores, nariceros, planchas, fusores...*

*Hair clippers and trimmers, shavers, hair dryers,
nose trimmers, hair straighteners, wax heaters...*







*Potencia, calidad,
elegancia y diseño
Power, quality,
elegance and design*



RAGNAR
BARBER LINE

Máquina corta cabello GALAXY FADING GALAXY FADING hair cutting machine

RAGNAR
BARBER LINE

u.m.vta: 1  12 

REF. 07220



*Especial Fade
Fade Special*

- Preparada para Fade
- Sin palanca reguladora de cuchilla
- Cuchilla fija ajustable al 0,2 - 0,3
- Voltaje: 100-240V~
- Frecuencia: 50/60Hz
- Potencia: 8W
- 5500 r.p.m. (+/-100)
- Grado degradación: 0,2 - 0,3 mm
- Cuchilla de Acero Japonés
- Cuchilla fija de Titanio
- Cepillo de limpieza
- Bote de aceite lubricante
- Protector cuchilla
- Fuente de alimentación
- Pantalla LCD multifunción

- Ready for Fade
- Without blade regulating lever
- Fixed blade adjustable to 0.2 - 0.3
- Voltage: 100-240V~
- Frequency: 50/60 Hz
- Power: 8 W
- 5500 CPM (+/-100)
- Degree of degradation: 0.2-0.3 mm
- Japanese steel blade
- Titanium fixed blade
- Cleaning brush
- Bottle of lubricating oil
- Blade protector
- Power supply unit
- Multifunction LCD screen

Recambios · Spare parts

Cuchilla · Blade



REF.07389



Máquina corta cabello GALAXY CERAMIC

GALAXY CERAMIC hair cutting machine

Ideal para trabajar muchas horas
Ideal for working long hours

u.m.vta: 1  12 

REF. 07221



Cuchilla cerámica.

Reduce el calentamiento de la cuchilla

Ceramic blade

Reduces heating of the blade

- Voltaje: 100-240V~
- Frecuencia: 50/60Hz
- Potencia: 8W
- 5500 r.p.m. (+/-100)
- Grado degradación: 0,5mm
- Palanca reguladora de cuchilla
- CUCHILLA DE CERÁMICA y cuchilla fija de titanio
- 6 peines adaptadores de medida (1.5, 3, 4.5, 6, 10 y 13 mm)
- Cepillo de limpieza
- Bote de aceite lubricante
- Protector cuchilla
- Fuente de alimentación
- Pantalla LCD multifunción
- Cuchilla cerámica

- Voltage: 100-240V~
- Frequency: 50/60 Hz
- Power: 8 W
- 5500 CPM (+/-100)
- Degree of degradation: 0.5 mm
- Blade adjustment lever
- CERAMIC KNIFE and fixed titanium blade
- 6 measurement adapter combs (1.5, 3, 4.5, 6, 10, 13 mm)
- Cleaning brush
- Bottle of lubricating oil
- Blade protector
- Power supply unit
- Multifunction LCD screen
- Ceramic blade

Cuchilla · Blade

REF.07388



Más
información
More
information

SCAN
ME!



Máquina de corte GALAXY
GALAXY hair clipper

RAGNAR
BARBER LINE



Ragnar
GALAXY
06714



SCAN
ME!



Ragnar
GALAXY
06714/50

SCAN
ME!



u.m.vta: 1  12 

REF. 06714

REF. 06714/50



- Palanca reguladora de cuchilla
- Cuchilla de acero japonés
- 6 peines adaptadores de medida (1.5, 3, 4.5, 6, 10 y 13 mm)
- Cepillo de limpieza
- Bote de aceite lubricante
- Protector cuchilla
- Fuente de alimentación
- Pantalla LCD multifunción
- Potencia máxima: 8 W
- Voltaje: 100-240 V~
- Frecuencia: 50/60 Hz
- Revoluciones por minuto: 5500+/-100 rpm
- Grado degradación: 0,5mm

- Blade adjustment lever
- Japanese steel blade
- 6 measurement adapter combs (1.5, 3, 4.5, 6, 10, 13 mm)
- Cleaning brush
- Bottle of lubricating oil
- Blade protector
- Power supply unit
- Multifunction LCD screen
- Maximum power: 8 W
- Voltage: 100-240 V~
- Frequency: 50/60 Hz
- Cycles per minute: 5500+/-100 cpm
- Degree of degradation: 0.5 mm

Peine · Comb**Recambios · Spare parts**

1,5 mm REF. RE06985/01	3 mm REF. RE06985/02	4,5 mm REF. RE06985/03
6 mm REF. RE06985/04	10 mm REF. RE06985/05	13 mm REF. RE06985/06

**Cuchilla · Blade**

Plana Flat REF. 06983	Estándar Standard REF. 06984
-----------------------------	------------------------------------

**Pack 6 peines metálicos · Pack 6 metal combs**

REF. 06985



Máquina de corte SUPERNOVA
SUPERNOVA hair clipper



RAGNAR
BARBER LINE



*¿Quieres
saber más?
Do you want
to know more?*

**SCAN
ME!**



u.m.vta: 1  12 

REF. 06715

REF. 06715/50



- Palanca reguladora de cuchilla
- Cuchilla de acero japonés
- 6 peines adaptadores de medida (1.5, 3, 4.5, 6, 10, 13 mm)
- Cepillo de limpieza
- Bote de aceite lubricante
- Protector cuchilla
- Fuente de alimentación
- Función turbo
- Pantalla LCD multifunción
- Potencia máxima: 8 W
- Voltaje: 100-240 V~
- Frecuencia: 50/60 Hz
- Revoluciones por minuto: 5500+/-100 rpm
- Turbo: 5700/-100 rpm
- Grado degradación: 0,5mm

- Blade adjustment lever
- Japanese steel blade
- 6 measurement adapter combs (1.5, 3, 4.5, 6, 10, 13 mm)
- Cleaning brush
- Bottle of lubricating oil
- Blade protector
- Power supply unit
- Turbo function
- Multifunction LCD screen
- Maximum power: 8 W
- Voltage: 100-240 V~
- Frequency: 50/60 Hz
- Cycles per minute: 5500+/-100 cpm
- Turbo: 5700-100 - cpm
- Degree of degradation: 0.5 mm

Peine · Comb**Recambios · Spare parts**

1,5 mm REF. RE06985/01	3 mm REF. RE06985/02	4,5 mm REF. RE06985/03
6 mm REF. RE06985/04	10 mm REF. RE06985/05	13 mm REF. RE06985/06

**Cuchilla · Blade**

Plana Flat	Estándar Standard
REF. 06983	REF. 06984

**Pack 6 peines metálicos · Pack 6 metal combs**

REF. 06985



Máquina de corte EAGLE

EAGLE hair clipper

u.m.vta: 1  6 

REF. 06390

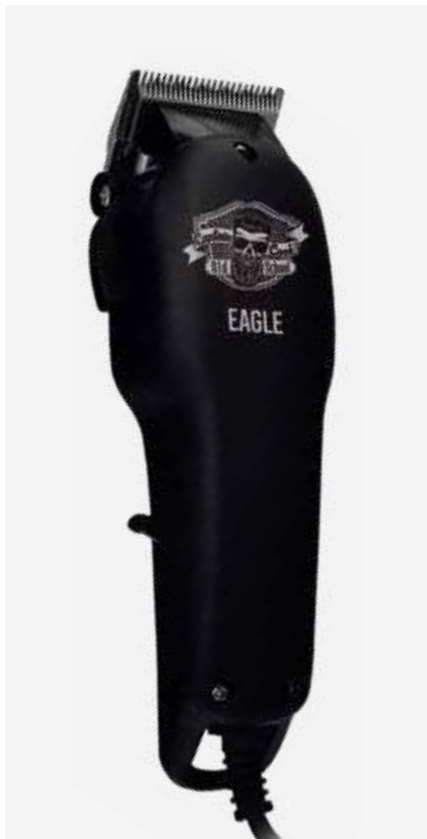

- Con cable 2,5 m
- Incluye 6 peines metálicos y 2 cuchillas
- Con cuchillas de acero japonés
- Voltaje: 220-240 V~
- Frecuencia: 50 Hz
- Potencia máxima: 10 W
- Revoluciones por minuto: 6500 +/- 800 rpm
- Apto para cualquier tipo de cabello natural
- Grado degradación: 0,5mm

- With cable 2,5 m
- Includes 6 metal combs and 2 blades
- With Japanese steel blades
- Voltage: 220-240 V ~
- Frequency: 50 Hz
- Maximum power: 10 W
- Cycles per minute: 6500 +/- 800 cpm
- Suitable for any type of natural hair
- Degree of degradation: 0.5 mm

Máquina corte FALCON

FALCON hair clipper

u.m.vta: 1  6 

REF. 06391



- Sin cable
- Incluye 6 peines metálicos y 2 cuchillas
- Con cuchillas de acero japonés
- Voltaje: 100-240 V~
- Frecuencia: 50/60 Hz
- Potencia máxima: 5 W
- Revoluciones por minuto: 5500 +/- 800 rpm
- Entrada adaptador: 0,2 A
- Salida adaptador: 5V 600mA
- Apto para cualquier tipo de cabello natural
- Grado degradación: 0,5mm

- Without cable
- Includes 6 metal combs and 2 blades
- With Japanese steel blades
- Voltage: 100-240 V ~
- Frequency: 50 / 60 Hz
- Maximum power: 5 W
- Cycles per minute: 5500 +/- 800 cpm
- Input adapter: 0.2 A
- Output adapter: 5V 600mA
- Suitable for any type of natural hair
- Degree of degradation: 0.5 mm

Recambios · Spare parts**Peine · Comb**

1,5 mm

REF. RE06602/01

3 mm

REF. RE06602/02

4,5 mm

REF. RE06602/03

6 mm

REF. RE06602/04

10 mm

REF. RE06602/05

13 mm

REF. RE06602/06

**Cuchilla · Blade**

Estándar

Standard

REF. 06603

REF. 07327



Plana

Flat

REF. 06604

REF. 07326

**Pack 6 peines metálicos · Pack 6 metal combs**

REF. 06602

Compatible con 06390, 06391, 06666
Compatible with 06390, 06391, 06666

Máquina corte K-3600
K-3600 hair clipper



u.m.vta: 1 20

REF. 03752

REF. 03752/50



- Potencia: 5 W
- Voltaje: 200-240 V~
- Frecuencia 50 Hz
- Salida adaptador: 3V ~500 mA
- Accesorios: 4 peines
- Cabezal de corte cerámico con movimiento ajustable en medida de corte
- Cuchilla fija de titanio
- Cable de alimentación
- 2 baterías recargables
- Cepillo de limpieza
- Botella aceite lubricante

- Power: 5 W
- Voltage: 200-240 V~
- Frequency 50 Hz
- Adapter output: 3V ~ 500 mA
- Accessories: 4 combs
- Ceramic cutting head with adjustable movement in cutting measure
- Fixed titanium blade
- Feeder cable
- 2 rechargeable batteries
- Cleaning brush
- Lubricating oil bottle

Tiempo de trabajo de 60/90 min
Working time 60/90 Min

Se puede usar batería o corriente eléctrica
It can run on batteries or on the electric grid

5h de carga
5h charging time

Cabezal cerámico y cuchilla de titanio
Ceramic headpiece and titanium blade

Peine · Comb

3 mm
REF. RE03752/07

6 mm
REF. RE03752/08

9 mm
REF. RE03752/09

12 mm
REF. RE03752/10



Recambios · Spare parts

Cabezal · Head

REF. RE03752/01

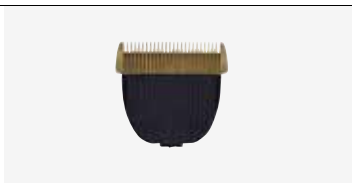



Batería · Battery

REF. RE03752/03



Máquina corte K-3000
K-3000 hair clipper

u.m.vta: 1  20 

REF. 03753



SCAN ME!

- Potencia: 3 W
- Cuchillas de 8 mm, 30 mm, 40 mm para detalles, cabezal nariz/orejas y cabezal afeitado
- Hoja intercambiable fácil de limpiar
- Baja vibración y muy silenciosa
- LED indicador de carga
- Carga de larga duración, hasta 60 minutos de autonomía
- Longitud ajustable de corte 4 niveles: 3 mm, 6 mm, 9 mm y 12 mm

- Power: 3 W
- 30 mm, 40 mm and 8 mm blades for details, nose/ear headpiece and shaving headpiece
- Easy to clean and interchangeable blades
- Silent, with low vibrations
- LED charge indicator
- Long battery life, can run for up to 60 minutes
- Adjustable cutting length with 4 levels: 3 mm, 6 mm, 9 mm and 12 mm



Máquina profesional corta cabello para retoques en barba, nariz y orejas

Professional hair clipper for touch-ups on beard, nose and ears.



Cabezal · Head

Recambios · Spare parts

Nariz Nose	Afeitado Shaving
REF. RE03753/07	REF. RE03753/08

8 mm	30 mm	40 mm
REF. RE03753/06	REF. RE03753/04	REF. RE03753/05





Peines · Combs

REF. RE03753/01



Máquina de retoques COSMIC
COSMIC touch-up machine

RAGNAR
 BARBER LINE

u.m.vta: 1  20 



REF. 06713



REF. 06713/50



SCAN ME!



- Cabezal de corte de 38 mm
- Cuchilla fija de acero inoxidable
- Peine adaptador medida de corte (2,3 y 4 mm)
- Cepillo de limpieza
- Bote de aceite lubricante
- Cable de alimentación
- Botón de encendido y apagado
- Pantalla LCD multifunción
- Potencia máxima: 5 W
- Voltaje: 100-240 V~
- Frecuencia: 50/60 Hz
- Revoluciones por minuto: 5500+/-100 rpm

- 38 mm cutting head
- Stainless steel fixed blade
- Adapter comb for cutting size (2, 3 and 4 mm)
- Cleaning brush
- Bottle of lubricating oil
- Power cord
- On and off button
- Multifunction LCD screen
- Maximum power: 5 W
- Voltage: 100-240 V~
- Frequency: 50/60 Hz
- Cycles per minute: 5500+/-100 cpm



Peine · Comb

Recambios · Spare parts

2 mm 3 mm 4 mm
 REF. RE06713/01 REF. RE06713/02 REF. RE06713/03



Cuchilla · Blade

REF.06982

Trimmer T-zero
 T-zero trimmer





Máquina de retoques TRIUMPH

TRIUMPH touch-up machine

u.m.vta: 1 6

REF. 06667



- Sin cable
- Cabezal de corte de 38 mm
- Cuchilla fija de acero inoxidable
- Peine adaptador para medida de corte (1,2 y 3 mm)
- Cepillo de limpieza
- Bote de aceite lubricante
- Cable de alimentación
- **BASE DE CARGA**
- Botón de encendido y apagado
- Potencia máxima: 10W
- Voltaje: 100-240V~
- Frecuencia: 50/60Hz
- Revoluciones por minuto: 5500+/-800 rpm
- Grado degradación: 0,1mm

- Without cable
- 38 mm cutting head
- Stainless steel fixed blade
- Adapter comb for cutting size (2, 3 and 3 mm)
- Cleaning brush
- Bottle of lubricating oil
- Power cord
- **CHARGING BASE**
- On and off button
- Maximum power: 10W
- Voltage: 100-240V~
- Frequency: 50/60Hz
- Cycles per minute: 5500+/-800 cpm
- Degree of degradation: 0.1 mm



Novedad
Con base cargador

New
With charger base

Peine · Comb

Recambios · Spare parts

1 mm

REF. RE06667/05



2 mm

REF. RE06667/06

3 mm

REF. RE06667/07



Cuchilla · Blade



REF. RE06667/01

Con tornillos ajustables
With adjustable screws



Máquina de retoques THUNDER

THUNDER touch-up machine

u.m.vta: 1  6 

REF. 06666



- Palanca reguladora de cuchilla
- 2 cuchillas de acero japonés
- 6 peines adaptadores de medida (1.5, 3, 4.5, 6, 10, 12 mm)
- Cepillo de limpieza
- Bote de aceite lubricante
- Protector cuchilla
- Potencia máxima: 10W
- Voltaje: 100-240V~
- Frecuencia: 50/60Hz
- Revoluciones por minuto: 5500+/-800 rpm
- Grado degradación: 0,5mm
- **BASE DE CARGA**

- Blade adjustment lever
- 2 Japanese steel blades
- 6 measurement adapter combs (1.5, 3, 4.5, 6, 10, 12 mm)
- Cleaning brush
- Bottle of lubricating oil
- Blade protector
- Maximum power: 10W
- Voltage: 100-240V~
- Frequency: 50/60Hz
- Cycles per minute: 5500+/-800 cpm
- Degree of degradation: 0.5 mm
- **CHARGING BASE**



Novedad
Con base cargador

New
With charger base

Recambios · Spare parts

pag. 423



Pack nº1 "5° Aniversario" CAPTAIN COOK
Pack 1 "5th Anniversary" CAPTAIN COOK

u.m.vta: 1  1

REF. 07276

Contiene:

- Cepillo Fade - 04977
- Tijera black ripper esculpir 6" - 06479
- Máquina de corte Thunder - 06666
- Neceser Captain Cook - 07079

Contains:

- Fade Brush - 04977
- Black ripper carving scissors 6" - 06479
- Thunder cutting machine - 06666
- Captain Cook Toilet bag - 07079



Pack nº2 "5° Aniversario" CAPTAIN COOK
Pack 2 "5th Anniversary" CAPTAIN COOK

u.m.vta: 1  1

REF. 07330

Contiene:

- Máquina de corte TRIUMPH - 06667
- Cepillo Fade - 04977
- Tijera esculpir 6" Black ripper - 06479
- Neceser Captain Cook - 07079

Contains:

- TRIUMPH cutting machine
- Fade Brush 04977
- Black ripper carving scissors 6" 06479
- Captain Cook Toilet bag 07079



Máquina retoque AIRFLIP
AIRFLIP retouching machine

u.m.vta: 1  6 

REF. 07282



- Voltaje: 100-240V~
- Frecuencia: 50/60Hz
- Potencia: 8W
- 6500 r.p.m. (+/-500)
- Cabezal de corte de 38 mm
- Protector de cuchilla
- Cuchilla fija de Acero Inoxidable
- Peine adaptador para medida de corte (1,2 y 3 mm)
- Cepillo de limpieza
- Bote de aceite lubricante
- Cable de alimentación

- **BASE DE CARGA**
- Tapa transparente
- Grado degradación: 0,1mm



- Voltage: 100-240V~
- Frequency: 50/60 Hz
- Power: 8W
- 6500 CPM (+/-500)
- 38 mm cutting head
- Blade protector
- Stainless-steel fixed blade
- Adapter comb for cutting size (2, 3 and 3 mm)
- Cleaning brush
- Bottle of lubricating oil
- Power cord
- **CHARGING BASE**
- Transparent cover
- Degree of degradation: 0.1 mm

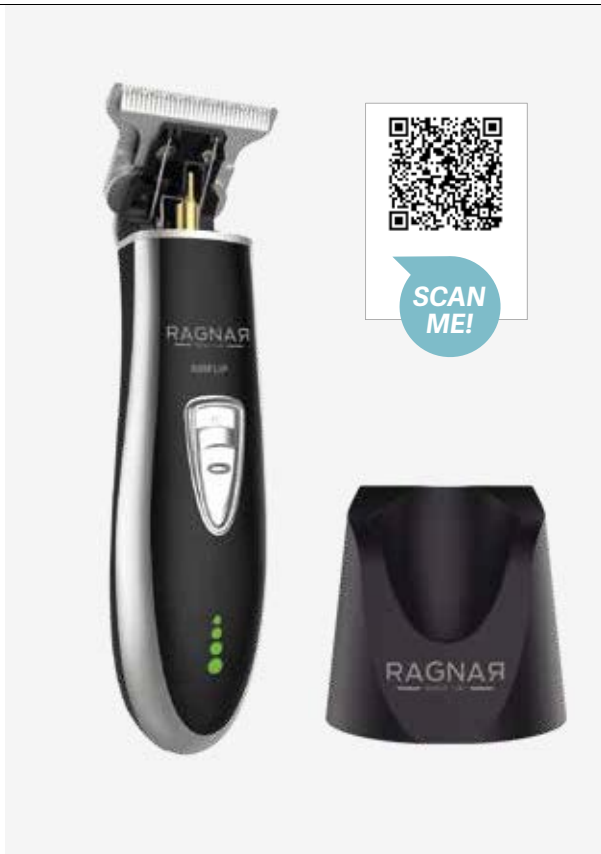

Visión corte de cuchilla
Cutting vision knife

Peine · Comb

1 mm

REF. RE07282/01

2 mm

REF. RE07282/02

3 mm

REF. RE07282/03



Recambios · Spare parts



Cuchilla · Blade

REF.07324

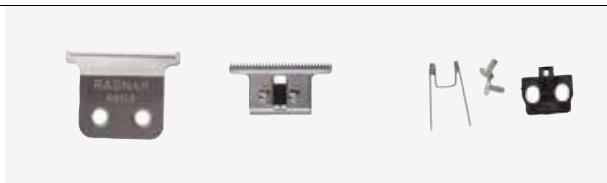

Máquina retoque **DRAKE**

DRAKE retouching machine



u.m.vta: 1 20

REF. 07283



- Voltaje: 100-240V~
- Frecuencia: 50/60Hz
- Potencia: 8W
- 7000+/-500 rpm
- Cabezal de corte de 38 mm
- Cuchilla fija de Acero Inoxidable
- Peine adaptador para medida de corte (1,2 y 3 mm)
- Cepillo de limpieza
- Bote de aceite lubricante
- Cable de alimentación
- Tapa transparente
- Grado degradación: 0,1mm

- Voltage: 100-240V~
- Frequency: 50/60 Hz
- Power: 8W
- 7000+/-500 cpm
- 38 mm cutting head
- Stainless-steel fixed blade
- Adapter comb for cutting size (2, 3 and 3 mm)
- Cleaning brush
- Bottle of lubricating oil
- Power cord.
- Transparent cover
- Degree of degradation: 0.1 mm



Visión corte de cuchilla
Cutting vision knife



Cuchilla · Blade

Recambios · Spare parts



REF.07325



Afeitadora COMET

COMET beard shaver

RAGNAR
 BARBER LINE

 u.m.vta: 1  20 

REF. 07084/50

REF. 07084/54

 SCAN
 ME!

Gracias por elegir nuestra nueva máquina afeitadora COMET 07084/50 – 07084/54 de barba recargable de “RAGNAR”, diseñada para el uso del profesional. Motor potente y de larga duración, súper silencioso y de baja vibración. Fabricada con materiales de alta calidad y de última generación.

- Voltaje: 100-240V~
- Frecuencia: 50/60Hz
- Potencia : 5W
- Revoluciones por minuto: 8.000-9.000 rpm
- Entrada adaptador: : 0,2 A
- Salida adaptador: 5V 1000mA
- Tiempo de carga: 3 horas
- Tiempo de funcionamiento: más de 80 minutos
- Batería de litio
- Apto para cualquier tipo de cabello natural
- Condiciones ambientales idóneas para su utilización: uso en interiores
- Temperatura -5° a 40°C
- Humedad relativa igual o menor al 80%

Thank you for choosing the rechargeable beard shaver COMET 07084/50-07084/54 from the “RAGNAR”, designed for professional use. Using long lasting, super silent, low vibration powerful motors made from the latest high quality materials.



- Voltage: 100-240 V~
- Frequency: 50/60Hz
- Power: 5W
- Cycles per minute: 8.000-9.000 cpm
- Input: 0, 2 A
- Output: 5 V 1000 mA
- Charging time: 3 hours
- Operating time: more than 80 minutes
- Lithium battery
- Suitable for any type of natural hair
- Suitable environmental conditions for use: indoor use
- Temperature between -5° and 40 °C
- Relative humidity less than or equal to 80%



Cabezal completo con cuchilla

Complete head with blade

Recambios · Spare parts

 u.m.vta: 1  100 

REF. RE07084/50/01

REF. RE07084/54/01



Afeitadora Bucanero

Bucanero shaver

Barber Line

u.m.vta: 1  24 

REF. 06412/50

Máquina afeitadora de barba BUCANERO, con batería recargable de "Barber Line", diseñada para el uso del profesional. Motor potente y de larga duración, super silencioso y de baja vibración. Fabricada con materiales de alta calidad y de última generación.

- Voltaje: 100-220 V~
- Frecuencia: 50/60 Hz
- Potencia: 3W
- Revoluciones por minuto: 6800 rpm
- Entrada adaptador: 3-5 W
- Salida adaptador: 2W
- Tiempo de carga: 2 horas
- Tiempo de funcionamiento: más de 90 minutos
- Batería de litio
- Apto para cualquier tipo de cabello natural

"Barber Line" rechargeable beard shaver BUCANERO 06412, designed for professional use. Powerful and long-lasting engine, super silent and low vibration. Made with high quality materials and latest generation.

- Voltage: 100-220 V ~
- Frequency: 50 / 60 Hz
- Power: 3W
- Cycles per minute: 6800 cpm
- Adapter input: 3-5 W
- Output adapter: 2W
- Charging time: 2 hours
- Operating time: more than 90 minutes
- Lithium battery
- Suitable for any type of natural hair





SCAN ME!



Cabezal completo con cuchilla

Complete head with blade

Recambios · Spare parts

u.m.vta: 1  12 



REF. RE06412/01

REF. RE06412/50/01



Afeitadora Roadster

Roadster shaver

u.m.vta: 1  12 

REF. 06411

Máquina afeitadora de barba ROADSTER, con batería recargable de "Captain Cook", diseñada para el uso del profesional. Motor potente y de larga duración, super silencioso y de baja vibración. Fabricada con materiales de alta calidad y de última generación.

- Voltaje: 100-220 V~
- Frecuencia: 50/60 Hz
- Potencia: 3W
- Revoluciones por minuto: 6800 rpm
- Entrada adaptador: 3-5W
- Salida adaptador: 2W
- Tiempo de carga: 2 horas
- Tiempo de funcionamiento: más de 90 minutos
- Batería de litio
- Apto para cualquier tipo de cabello natural



Thank you for choosing our new "Captain Cook" rechargeable beard shaver ROADSTER 06411, designed for professional use. Powerful and long-lasting engine, super silent and low vibration. Made with high quality materials and latest generation.

- Voltage: 100-220 V ~
- Frequency: 50/60 Hz
- Power: 3W
- Cycles per minute: 6800 cpm
- Adapter input: 3-5W
- Output adapter: 2W
- Charging time: 2 hours
- Operating time: more than 90 minutes
- Lithium battery
- Suitable for any type of natural hair



Cabezal completo con cuchilla

Complete head with blade

u.m.vta: 1  12 

REF. RE06411/01

Recambios · Spare parts



Máquina naricero Eurostil

Eurostil nose trimmer

- Batería no incluida
- Battery not included

EURO *stil*
PROFESIONAL

u.m.vta: 1  100 

REF. 04268

- Se puede mojar
- Con base y 2 accesorios

- Waterproof
- With base and 2 accessories

REF. 04269



- No se puede mojar
- No waterproof



Maquinilla retoque

Retouch trimmer

Batería no incluida
Battery not included

u.m.vta: 1  100 



REF. 04270



- Diseño ergonómico
- Suave con la piel sensible
- Interruptor de on/off
- 2 niveles de corte: para 2 mm de largo / para 5 mm de largo
- Tapa protectora
- Cabezal en ángulo para facilitar su uso
- Fuente de alimentación
- 1 pila AAA (no incluida)

- Ergonomic design
- Gentle on sensitive skin
- On / off switch
- 2 cutting levels: for 2 mm length / for 5 mm length
- Protective lid
- Angled headpiece for increased ease of use
- Power supply unit
- 1 AAA battery (not included)

Aceite máquina Oil machine

u.m.vta: 1  12 

Perfume intenso
Intense perfume

500 ml

REF. 06272

RAGNAR
BARBER LINE

500 ml



Perfume suave
Soft perfume

REF. 06395





500 ml



Aceite para máquinas de uso profesional. Refrigerante, higienizante, lubricante y antioxidante. Imprescindible para un mantenimiento óptimo de las cuchillas. Rociar a una distancia de 15-20cm aproximadamente de la parte superior lateral del cabezal de la máquina.

Oil for machines of professional use. Refrigerant, sanitizing, lubricant and antioxidant. It's essential for optimal maintenance of the blades. Spray at a distance of 15-20cm approx from the top and side of the machine head.

Botella aceite engrase Oiling oil bottle

u.m.vta: 1  10 

De engrase
Oiling

100 ml

REF. 03751

100 ml



Este aceite especial para máquinas de corte de la marca Eurostil es un aceite mineral ligero que mejora el tiempo de elevación de la hoja mejorando así el corte de la misma. No irrita.

This special oil for cutting machines of the Eurostil brand is a light mineral oil that improves the blade's lifting time thus improving cutting. It does not irritate.

Alfombra barberia RAGNAR
RAGNAR barber rug

Material: goma
 Material: rubber

u.m.vta: 1  5

REF. 07386



Alfombra barberia CAPTAIN COOK
CAPTAIN COOK barber rug

Material: goma
 Material: rubber



u.m.vta: 1  5

REF. 07387



Secador COMPACT PROFESSIONAL

COMPACT PROFESSIONAL hair dryer

u.m.vta: 1  6 

REF. 04202



¿Quieres
saber más?
Do you want
to know more?

SCAN
ME!

*Motor potente
con generador de iones*

*Powerful engine
with ion generator*



El secador Compact profesional tiene un diseño atractivo, ergonómico y ligero. Disponible en negro, blanco y blanco con gomas de colores. Motor potente con generador de iones. Incluye dos boquillas de diferentes medidas.

- Potencia: 2000W
- Motor compacto de larga duración AC
- Peso: 580 g
- Caudal de aire: 90 m³/hora
- 2 velocidades, 3 temperaturas
- Botón de aire frío
- 2 boquillas orientables de 62mm y 70mm
- Filtro extraíble
- Termostato de seguridad
- Cable flexible 3m con anilla para colgar
- Bajo nivel sonoro
- Voltaje 220-240V~
- Frecuencia: 50/60 Hz
- Diseño ergonómico
- Carcasa robusta y ligera en poliamida
- Embellecedor de goma antideslizante
- Motor generador de iones
- Compatible con difusor 04346/50 - 01147 - 03036/50



The Compact Professional hair dryer has an attractive, ergonomic and lightweight design. It is available in black, white and white with coloured rubber fittings. It has a powerful engine with ion generator. It includes two nozzles of different sizes.



- Power: 2000W
- AC long-life compact motor
- Weight: 580 g
- Air flow: 90m³/ hour
- 2 speeds, 3 temperatures
- Cold air button
- 2 adjustable nozzles 62mm and 70mm
- Removable filter
- Safety thermostat
- Extra flexible 3m cable with ring for hanging
- Low sound level
- Voltage 220-240V ~
- Frequency: 50/60 Hz
- Ergonomic design
- Sturdy and lightweight polyamide frame
- Anti-slip rubber embellishment
- Engine with ion generator
- Compatible with 04346/50 - 01147 - 03036/50 diffuser

Secador COMPACT EXTRA LIGHT

COMPACT EXTRA LIGHT hair dryer

COMPACT
extra light

u.m.vta: 1  6 

u.m.vta: 1  12 



REF. 04203



REF. 04203/58



El secador Compact Extra Light tiene un diseño atractivo, ergonómico y ligero. Disponible en negro, blanco y blanco con gomitas de colores. Motor potente con generador de iones. Incluye dos boquillas de diferentes medidas.

- Potencia: 1800W
- Motor DC
- Peso: 430 g
- Caudal de aire: 76 m³/hora
- 2 velocidades, 3 temperaturas
- Botón de aire frío
- 2 boquillas orientables de 62mm y 70mm
- Filtro extraíble
- Termostato de seguridad
- Cable flexible 3m con anilla para colgar
- Muy bajo nivel sonoro
- Voltaje 220-240V~
- Frecuencia: 50/60 Hz
- Compacto y MÁS LIGERO
- Embellecedor de goma antideslizante
- Motor con generador de iones
- Compatible con difusor 04346/50 - 01147 - 03036/50



The Compact Extra Light hair dryer has an attractive, ergonomic and lightweight design. It is available in black, white and white with coloured rubber fittings. It has a powerful engine with an ion generator. It includes two nozzles of different sizes.

- Power: 1800W
- DC motor
- Weight: 430 g
- Air flow: 76 m³/hour
- 2 speeds, 3 temperatures
- Cold air button
- 2 adjustable nozzles 62mm and 70mm
- Removable filter
- Safety thermostat
- Extra flexible 3m cable with ring for hanging
- Low sound level
- Voltage 220-240V ~
- Frequency: 50/60 Hz
- Compact and LIGHTER
- Anti-slip rubber embellishment
- Engine with ion generator
- Compatible with 04346/50 - 01147 - 03036/50 diffuser

Secador Robust Barber Line

Barber Line Robust hair dryer

Barber Line

u.m.vta: 1  12 

REF. 06475



SCAN
ME!



Realizado como complemento ideal para el peluquero. El nuevo secador de pelo ROBUST de Barber Line ofrece un gran caudal de aire, un aumento del rendimiento y la reducción del tiempo de secado. Permite crear cualquier tipo de peinado: alisados, ondulados, volumen, etc. El cabello se verá suave, brillante y sano.

Conceived as an ideal complement for the hairdresser. The new Barber Line ROBUST hair dryer offers great airflow, increased performance and reduced dry time. Create any style: straight, wavy, volume, etc. The hair will be soft, shiny and healthy.



- Potencia: 1900W - 2200W
- Voltaje: 220-240V~
- Frecuencia: 50/60 Hz

- Power: 1900W - 2000W
- Voltage: 220-240V ~
- Frequency: 50/60 Hz



Fusor cera negro Barber Line 125 ml Barber Line 125 ml black wax heater

Barber Line

u.m.vta: 1  12 

REF.04505





- Calentador de cera compacto
- Superficie antiadherente para facilitar la limpieza
- Ajustes de temperatura variable
- Calentamiento rápido
- Tapa protectora
- Capacidad: 125 ml
- Voltaje: 220-240V~
- Potencia: 40 W
- Frecuencia: 50 Hz
- Temperatura máxima 90°C

- Compact wax heater
- Non-stick surface for easy cleaning
- Variable temperature settings
- Fast heating
- Protective cover
- Capacity: 125 ml
- Voltage: 220 – 240 V~
- Power: 40 W
- Frequency: 50 Hz
- Max. temperature 90°C



Plancha pequeña Barber Line para barba y flequillo Barber Line small straightener for beard and bangs

u.m.vta: 1  20 

REF. 06569/50



Las nuevas planchas mini Barber Line de última generación permiten crear cualquier tipo de peinado ondulado, liso, etc. Uso profesional.

- Placas de cerámica con turmalina que cuidan el cabello proporcionando brillo y suavidad
- Voltaje: 100-240V~
- Frecuencia: 50/60 Hz
- Potencia: 22 W
- Cable de goma de 2 m de largo
- Calentamiento de placas en tan sólo 30 segundos, con resistencia PTC
- Temperatura máxima 200°C
- Resistencia PTC que evita el sobrecalentamiento
- Apta para cualquier tipo de cabello natural
- NO UTILIZAR PARA CABELLO SINTÉTICO
- NO APTA PARA CABELLO MOJADO

The new state-of-the-art mini Barber Line straighteners allow you to create any type of hairstyle, wavy, smooth, etc. Professional use.

- The tourmaline ceramic plates take care of hair, making it shiny and soft
- Voltage: 100-240V~
- Frequency: 50/60 Hz
- Power: 22W
- 2 metre rubber cable
- Plates heat up in only 30 seconds with PTC resistance
- Maximum temperature 200°C
- PTC thermistor to prevent overheating
- Suitable for any kind of natural hair
- DO NOT USE WITH SYNTHETIC HAIR
- NOT SUITABLE FOR WET HAIR

Aspirador de cabello Hair vacuum

u.m.vta: 1  1 

REF. 06612

PVP/R 187,72€

SCAN
ME!Depósito
Collection
BinBotón
Manual
Manual
buttonEntrada
de la suciedad
Dirt InletSensores
SensorsAUTO OFF
MANUAL
Dial de
control
AUTO OFF
MANUAL
Control dialIndicador del
estado de la luz
Status
indicator
lightFiltro
Filter

Aspirador de cabello de última tecnología. En el modo manual, barre los escombros hacia la entrada en la base de la unidad. Pulse el botón de activación manual y deje que HAIR VACUUM aspire los escombros a través de la entrada y los almacene en el depósito.

1. El modo MANUAL tendrá una duración de 5 segundos. Dependiendo de la cantidad de desechos, puede ser necesario pulsar el botón de activación manual más de una vez.
2. Cuando el dial de control se gira a la posición AUTO, barre los desechos hacia la entrada en la base de la unidad y los sensores detectan los escombros e inician automáticamente un ciclo de aspiración que se terminará una vez que los sensores no detectan desechos.

- Potencia nominal: 1400 W
- Modelo: VA001A-BK
- Tensión nominal: 220-240V~
- Frecuencia: 50/60Hz
- Tamaño: (largo x ancho x alto): 33 cm largo x 21 ancho x 56,4 cm alto
- Peso neto: acerca de 5.1Kg
- Ruido de la operación: ≥83db 1.5m
- Modo de trabajo automático: introducción de radiación infrarroja
- Succión (fuerza de tensión ≥2.8Kg
- Capacidad del tanque de basura: 2.7L MAX
- Tamaño de la exposición del cable de alimentación: 2m

Hair vacuum with the last technology. In the MANUAL mode, sweep debris towards the inlet at the base of the unit, press the manual activation button and let HAIR VACUUM vacuum the debris through the inlet and into the collection bin.

1. The MANUAL mode will run for 5 seconds. Depending on the amount of debris, it may be necessary to press the manual activation button more than once.
2. When the control dial is turned to the AUTO position, sweep debris towards the inlet at the base of the unit and the HAIR VACUUM sensors will detect the debris and automatically initiate a timed vacuuming cycle which will terminate once the HAIR VACUUM sensors no longer detect debris.

- Rated Power: 1400W
- Model: VA001A-BK
- Rated Voltage: 220-240V~
- Frequency: 50/60Hz
- Size: (long x wide x high): 33 cm long x 21 wide x 56.4 cm high
- Net weight: about 5.1Kg
- Operation noise: ≥83db 1.5m
- Automatic working mode: infrared radiation induction
- Suction (tensile force): ≥2.8 Kg
- Garbage tank capacity: 2.7L MAX
- Power cord exposure size: 2m

Esterilizador UV Eurostil aluminio Eurostil aluminum UV sterilizer

u.m.vta: 1  1

REF. 03317

- Potencia: 8W
- Indicado para la esterilización de pequeños utensilios en plástico o metal, mediante una bombilla de rayos UVC germicida
- No utilizar con otros objetos no indicados
- La bombilla dura unas 1300/1500 horas (= 1 año de funcionamiento)

- Power: 8W
- Recommended for sterilising small plastic or metal utensils; the device uses a UVC ray light bulb with a germicidal effect
- Should not be used with unsuitable objects
- The light bulb has a lifespan of 1300/1500 hours (= 1 year of use)



Esterilizador calor seco Sanity Security Sanity Security hot dry sterilizer

u.m.vta: 1  1

REF. 03011



- Temperatura de 20°C a 200°C
- Potencia: 400W
- Medidas internas: 25 cm x 14,5 cm x 7 cm

- Temperature: 20°C to 200°C
- Power: 400W
- Internal measures: 25 cm x 14,5 cm x 7 cm



Esterilizador EUROSTIL cuarzo

Quartz EUROSTIL sterilizer

u.m.vta: 1  6 

REF. 07013

- Potencia: 75W
- Voltaje: 220-240 V~
- Frecuencia: 50/60Hz

- Power: 75W
- Voltage: 220 - 240 V~
- Frequency: 50/60 Hz



- De cuarzo
- Ideal para utensilios metálicos, tijeras, etc.
- Incluye bolsa con bolitas de cuarzo

- Of quartz
- Ideal for metallic tools as scissors, etc.
- Includes bag with quartz beads



Bote esferas de cuarzo 500 g

Steriliser quartz spheres 500 g

u.m.vta: 1  12 

REF. 06619

Para esterilizar herramientas metálicas tanto de peluquería como de estética.

To sterilize metal tools for, both hairdressing and aesthetics.



Esterilizador germicida GX4

Germicidal GX4 sterilizer



u.m.vta: 1 20



REF. 03009/59

- Potencia: 15W
- Temperatura de 20°C a 200°C
- Ultra plano. Luz germicida alta calidad

- Power: 15W
- Temperature: 20°C to 200°C
- Ultra flat. High quality germicidal light



Recambio · Spare part

u.m.vta: 1 1

REF. RE00891/01

Recambio bombilla UV
Bulb replacement UV lamp



Esterilizador Eurostil UV plástico

Eurostil plastic UV sterilizer

u.m.vta: 1 1

REF. 06618

- Potencia: 8W
- Esterilizador de rayos ultravioleta para todo tipo de herramientas tanto de peluquería como de estética

- Power: 8W
- Ultraviolet ray sterilizer for all types of tools, both hairdressing and aesthetics



u.m.vta: 1 1

REF. RE06618/01

Recambio bombilla UV 8W
Bulb replacement UV lamp 8W

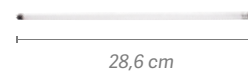



02

Navajas y cuchillas Razors & Blades

*Navajas, cuchillas, pen razor,
espumas y geles...*

*Razors, blades, pen razor,
shaving foam and shaving gel...*

Navaja afeitar REFINED
REFINED shaving razor

RAGNAR
 BARBER LINE

u.m.vta: 1  12

● Negra · Black

REF.07163



● Plata · Silver

REF.07161



● Cobre viejo · Old copper

REF.07162



- Medida: 14,5 cm
- Para media hoja acanalada
- ACERO J2 ALTA CALIDAD (420C)
- Logo marcado con laser

- Measurement: 14,5 cm
- For half ribbed blade
- HIGH-QUALITY J2 STEEL (420C)
- Laser marked logo



Navaja afeitar **PRECISE** PRECISE shaving razor

RAGNAR
BARBER LINE

u.m.vta: 1  100

REF.07124

- Ideal para retoques y afeitado
- Media hoja acanalada
- Mango negro
- Medidas: 15 x 2,6 x 1,1 cm
- Con baño de platino para un mejor afeitado y retoque

- *Ideal for touching up and shaving*
- *Half ribbed blade*
- *Black handle*
- *Measurements: 15 x 2.6 x 1.1 cm*
- *Platinum-plated for a better shave and touch up*



Navaja **RAGNAR** mango metálico negro RAGNAR razor black metal handle

u.m.vta: 1  25

REF.06986

- Navaja muy ligera para afeitado y retoques de barba y cabello con mango metálico negro.
- Media hoja.
- *Very light razor for shaving and retouches of beard and hair with black metallic handle.*
- *Half blade*



Maquinilla de afeitar clásica hoja completa
Classic full blade razor

Barber Line

u.m.vta: 1  12

REF.04929

u.m.vta: 1  7

REF.04550

u.m.vta: 1  6

REF.04933

Maquinilla de afeitar clásica, con hoja completa y de doble borde, una herramienta esencial para el barbero. La maquinilla de afeitar tiene un mango con una textura de acero inoxidable para una mejor sujeción. Adecuada para principiantes. Admite cualquier cuchilla de doble borde disponible en el mercado.

- Hoja completa de doble borde

Classic razor, with full blade and double edge, an essential tool for the barber. The razor has a handle with a stainless steel texture for a better grip. Suitable for beginners. Supports any double edge blade available in the market.

- Full double edge blade
- Full double edge blade

Maquinilla de afeitar clásica hoja completa
Classic full blade razor

u.m.vta: 1  12

REF.04931

- Maquinilla clásica de afeitar con hoja de doble borde y con mango de plástico para un mejor agarre.
- Incluye una elegante caja.
- Hoja completa de doble borde
- Classic double blade edge razor with plastic handle for a better grip. Includes an elegant case.
- Full double edge blade



Navaja afeitarse con mango madera

Wooden handle shaving razor

Barber Line

u.m.vta: 1  12

REF.04930

- Hoja de medio borde. Cambiable
- Half edge blade. Changeable



u.m.vta: 1  12

REF. 04983

Navaja de acero inoxidable 430, color negro, hecha en Japón. Revestimiento en negro y con mango de madera americana color naranja. Incluye una elegante caja de cartón.

- Hoja de medio borde

430 stainless steel blade, black color, made in Japan. Black coating and american wood handle orange color. Elegant carton case included.



Navaja afeitarse con mango plástico

Plastic handle shaving razor

u.m.vta: 1  10

REF.04898

- Hoja completa de doble borde
- Full double edge blade



Afeitarse puede convertirse en todo un acto de lujo y de cierto sibaritismo. Con Barber Line de Eurostil, con más de 75 años de experiencia en el mundo de la peluquería, hemos creado esta línea de productos para el hombre más actual con la elegancia del pasado.

Shaving can become a uniquely exquisite luxury with Eurostil's Barber Line. With over 75 years of experience in the world of hair styling, we have created this product line for modern men while preserving the elegance of olden times.

Navaja afeitador mango plástico
Plastic handle shaving razor

Barber Line

u.m.vta: 1  10

REF.06057

- Hoja de medio borde. Cambiable
- Half edge blade. Changeable



Navaja afeitador con mango metálico
Metallic handle shaving razor

u.m.vta: 1  10

REF.06058

- Hoja de medio borde. Cambiable
- Half edge blade. Changeable



Navaja de afeitador BARBER LINE
BARBER LINE shaving razor

u.m.vta: 1  12 

REF.06647

- Ideal para retoques
- Hoja completa doble borde
- Ideal for touch-ups
- Full double edge blade



Navaja negra pequeña
Small black shaving razor

u.m.vta: 1  12

REF.06435

- Muy corta, ideal para retoques y para zonas de difícil acceso
- Hoja de medio borde
- Very short, ideal for touch-ups and for areas of difficult access
- Half edge blade



Navaja para retoques Shaving razor

u.m.vta: 1  12

REF.06421

- Muy corta, ideal para retoques y para zonas de difícil acceso
- Hoja de medio borde

- *Very short, ideal for touch-ups and for areas of difficult access*
- *Half edge blade*



Navaja con protector y goma BARBER LINE BARBER LINE razor with protector and rubber

u.m.vta: 1  12

REF.06417

- Con goma
- Anilla giratoria en el mango para mayor comodidad

- *With rubber*
- *Rotating knob for confort*

REF.06419

*Barber Line*

REF.06420

- Sin goma
- *Without rubber*



Recambio Spare parts

REF. 07123



REF. 04388



REF. 04389





CONSEJO ADVICE

Cuando hayas terminado de afeitarte, lava la navaja con agua corriente para eliminar el vello y la espuma de la hoja. Sécala frotándola con un paño o una toalla. Hay muchos beneficios en afeitarse con navaja, los bajos costes de no comprar cuchillas de repuesto, el mejor control de las maniobras de un borde más grande de una hoja a través de la piel. Afeitarse correctamente a menudo proporciona una mayor suavidad, un afeitado más cercano, y un ritual que muchos miran con interés cada mañana.

When you have finished shaving, wash the razor with water to remove the hair and foam from the blade. Dry it by wiping with a cloth or towel. There are many benefits in shaving with a razor, the low costs of not buying spare blades, the better control of shunting a larger edge of a blade through the skin. Proper shaving often provides greater softness, more shaving nearby, and a ritual that many look forward every morning.

Navaja de afeitar Captain Cook Captain Cook shaving razor

u.m.vta: 1  10

REF.04894

Navaja de afeitar de precisión con mango de madera Captain Cook y con hoja completa de doble borde, ideal para el afeitado. Incluye una caja para su correcta conservación

Shaving razor with wooden handle of Captain Cook, and with full double edge blade, ideal for shaving. Includes a case for proper conservation



u.m.vta: 1  12

REF.04932

Navaja con cuchilla intercambiable universal. Ergonómica gracias al diseño del mango que la hace muy cómoda para realizar rasurados. Incluye un elegante estuche. Media hoja.

Razor with universal interchangeable blade. Thanks to ergonomic handle design, it is very comfortable to shave. Includes an elegant case. Half blade



u.m.vta: 1  12

REF.04984

Navaja clásica de afeitar con cuchilla intercambiable universal. Con mango de madera, incluye un cómodo estuche en polipiel. Media hoja

Classic shaving razor with universal interchangeable blade. With wooden handle, includes a comfortable imitation leather case. Half blade



u.m.vta: 1  12

REF.04985

Navaja de look vanguardista, de color negro con cuchilla intercambiable universal. Tiene el mango ancho de madera negro e incluye un cómodo estuche en polipiel. Media hoja

Avant-garde shaving razor, black colour with with universal interchangeable blade. It has the wide black wood handle and includes a comfortable imitation leather case. Half blade





Navaja negra pequeña Small black shaving razor

u.m.vta: 1  12

REF.06434

- Muy corta, ideal para retoques y para zonas de difícil acceso
- Hoja de medio borde
- *Very short, ideal for touch-ups and for areas of difficult access*
- *Half edge blade*



Navaja para retoques Retouching razor

u.m.vta: 1  12

REF.06422

- Muy corta, ideal para retoques y para zonas de difícil acceso
- Hoja de medio borde
- *Very short, ideal for touch-ups and for areas of difficult access*
- *Half edge blade*



Navaja negra con protector y goma Back razor with protector and rubber

u.m.vta: 1  12

REF.06418

- Con goma
- Anilla giratoria en el mango para mayor comodidad
- *With rubber*
- *Rotating knob for comfort*

u.m.vta: 1  12

REF.06423

- Sin goma
- *Without rubber*



Recambio
Spare parts

REF. 07123



REF. 04388



REF. 04389



Navaja hoja cambiabile
Changeable blade shaving razor

u.m.vta: 1 12

REF.02124

- Acero inoxidable
- Hoja de medio borde

- *Stainless steel*
- *Half edge blade*



Navaja de afeitar
Shaving razor

u.m.vta: 1 12

REF.00698

- Hoja de medio borde. Cambiable
- Acero inoxidable

- *Half edge blade. Changeable*
- *Stainless steel*

Navaja de cortar cabello
Cut hair razor

u.m.vta: 1 12

REF.00730

- Hoja de medio borde. Cambiable
- Con peine

- *Half edge blade. Changeable*
- *With comb*



Navaja de afeitar metálica
Metallic shaving razor

u.m.vta: 1 12

REF.04543

- Hoja de medio borde. Cambiable
- *Half edge blade. Changeable*

u.m.vta: 1 12

REF.04544

- Hoja de medio borde. Cambiable
- Mango negro de goma

- *Half edge blade. Changeable*
- *Black rubber handle*



Dispensador 20 cuchillas
20 blades dispenser

Professional PB-20

u.m.vta: 1  10

REF.04391



Navaja FEATHER ARTIST ACS-RB
FEATHER ARTIST ACS-RB razor



u.m.vta: 1  6

Artist ACS-RB
REF.04390



Navaja FEATHER ARTIST CLUB SS SCOTCH WOOD
FEATHER ARTIST CLUB SS SCOTCH WOOD razor

u.m.vta: 1  6

Artist ACS-RSW
REF.04902



Navaja FEATHER DOUBLE EDGE POPULAR
FEATHER DUBLE EDGE POPULAR razor

u.m.vta: 1  12

REF.04392



u.m.vta: 20  20

REF.04393

Caja de 10 cuchillas
DOUBLE EDGE
Box 10 DOUBLE EDGE
blades





Caja de 10 cajitas de 100 medias hojas inoxidable para uso profesional
Box of 10 boxes of 100 half-sheets, stainless-steel, for professional use

u.m.vta: 1  10 

REF.07164

- Media hoja
- Premium stainless, de corte suave y preciso
- 10 cajitas x 100 hojas

- Half blade
- Premium stainless, smooth and precise cutting
- 10 boxes x 100 sheets



Contenedor para depositar cuchillas usadas
Container to deposit used blades

u.m.vta: 1  6 

REF.07258

- De tamaño reducido, este contenedor es ideal para desechar las cuchillas de afeitar utilizadas por peluqueros y barberos.
- Color: negro
 - Dimensiones: base 7,5 x 7,5 cm parte superior 9 x 9 cm/ altura: 15 cm
 - Capacidad: 1l aprox.

- Small in size, this container is ideal for disposing of razor blades used by hairdressers and barbers.
- Colour: black
 - Dimensions: base 7,5 x 7,5 cm upper part 9 x 9 cm/ height: 15 cm
 - Capacity: 1l approx.



Dispensador de 20 cajas ELIOS
Dispenser of 20 boxes ELIOS

u.m.vta: 1  50 

REF. 00994

Hoja de afeitador referente para los profesionales. Mejor calidad de la hoja, mejor afilado y suavidad de uso.



Reference razor blade for professionals. Better blade quality, better sharpening and smooth use.

- Cuchillas de afeitador inoxidable
- Acero sueco tradicional de alta calidad
- Tratada con platino para un afeitado perfecto y seguro

- Stainless razors
- Traditional Swedish high quality steel
- Treated with platinum for a perfect and safe shave

- 11 hojas acanaladas ELIOS
- 11 ELIOS hole blades





u.m.vta: 1  240 

REF.01351



- 5 hojas acanaladas BIC
- 5 BIC hole blades

u.m.vta: 1  50 

REF.00995

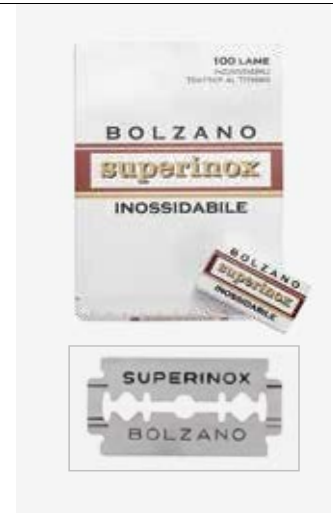



- 5 hojas acanaladas BOLZANO
- 5 BOLZANO hole blades

u.m.vta: 1  50 

REF. 06161





- 5 hojas acanaladas DERBY PREMIUM
- 5 DERBY PREMIUM hole blades

u.m.vta: 1  50 

REF.02956



- 5 hojas acanaladas
- 5 DERBY hole blades

u.m.vta: 1  80 

REF.02308



- 10 hojas Supermax
- 10 Supermax blades

Dispensador ASTRA 20 cajas 5 hojas
ASTRA dispenser 20 boxes 5 sheets

u.m.vta: 1  100 

REF.07100

Cuchillas de afeitar de alto afilado y gran suavidad. Están fabricadas en acero inoxidable y recubrimiento de platino.



La caja contiene veinte dispensadores de cartón con cinco cuchillas envueltas en papel parafinado en cada uno.

Razor blades providing a close and smooth shave. Made of stainless steel and coated with platinum.

The box contains twenty cardboard dispensers with five blades individually wrapped in paraffin paper.



Caja 100 hojas desechables
Box 100 disposable blades

u.m.vta: 1  50 

Derby Premium
 REF. 06160



Derby Professional
 REF. 02955



Caja de láminas
Blades box

u.m.vta: 1  50



REF.09101

- 10 hojas de recambio navaja 06192
- 10 removable blades 06192 shaving razor



Caja dispensadora 100 navajas desechables precintadas RAGNAR

Dispenser box of 100 RAGNAR sealed disposable razor blades

u.m.vta: 1  12 



REF. 07439

Fabricada en material plástico de primera calidad. Su hoja de acero inoxidable templado sueco, así como su perfecto afilado, aseguran una calidad profesional en cada corte. Ligera, cómoda y precisa en el rasurado o corte de cabello. La navaja de un solo uso RAGNAR es garantía de máxima higiene para su cliente, dado que dispone de un precinto de seguridad de fácil apertura.

Made of high-quality plastic material. The Swedish hardened stainless-steel blade and perfect sharpness ensure professional quality in every cut.

Lightweight, comfortable and precise shaving or haircutting. The RAGNAR single-use razor is a guarantee of maximum hygiene for your customer, as it has an easy-to-open seal.





u.m.vta: 1  7 

REF. 02479

- Caja de 100 navajas desechables Pollié
- Box 100 Pollié disposable razors



u.m.vta: 1  12 



REF. 01951

- Caja de 100 navajas desechables
- Box 100 disposable razors



Caja navajas desechables Eurostil

Box Eurostil disposable razors

u.m.vta: 1  15 

REF. 03882

- 100 navajas surtidas (3 colores)
- Diseño ergonómico
- 100 assorted (3 colours)
- Ergonomic design



Dispensador para navajas 03882

Dispenser for razors 03882

u.m.vta: 1  6

REF.04523

- Vacío
- Empty



Pen razor

Pen Razor

u.m.vta: 1  20

REF.06154

- Pen Razor + 20 cuchillas
- Pen Razor + 20 razors

Ideal para realizar dibujos en el cabello
Ideal for drawing on the hair



Ideal para realizar dibujos en el cabello
Ideal for drawing on the hair

u.m.vta: 1  200

REF.06155

- Dispensador 20 cuchillas Pen razor
- Box 20 Pen Razor razors

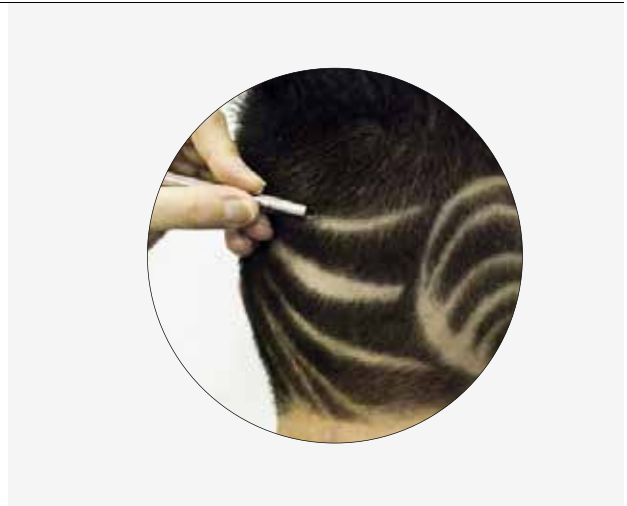

Espuma de afeitado BIC Sensitive

BIC Sensitive shaving foam

u.m.vta: 6  6

250 ml

REF.03286

Espuma especialmente formulada para pieles sensibles. Su fórmula con aloe vera es conocida por sus efectos calmantes y ayuda a aliviar la irritación provocada por el afeitado.

Foam specially formulated for sensitive skins. This formula enriched with aloe vera, which it's known for its calming effects, helps to release irritation caused by shaver.



A collection of professional hairdressing tools including scissors and combs, arranged on a wooden surface. The tools are shown in various colors: black, gold, and rose gold. Some are placed inside their black leather cases with white stitching, while others are out of their cases. The background is a light-colored wooden surface. A red box is visible in the upper left corner.

03

Tijeras Scissors

*Tijeras de corte y de
esculpir profesionales*

*Cutting and thinning
professional scissors*

Tijeras BARBER LINE · BARBER LINE scissors

Industrias Oriol presenta su línea de tijeras de alta calidad. Diseñadas para favorecer el trabajo al profesional gracias a su filo de precisión. Resistentes a gran desgaste y con un acabado en la fabricación manual para obtener la máxima calidad y precisión.

PROPIEDADES DEL MATERIAL

- Acero inoxidable VG-10 de altísima calidad, este acero es un excelente acero japonés alto en carbono. Este acero nos ofrece una mayor resistencia a la corrosión y una mayor capacidad de retener el filo. Su composición es la siguiente: carbono: 1,05% - 1,5% , manganeso: 0,5% , cromo: 14,5% - 15,5%, vanadio: 0,1 - 0,3%, molibdeno: 0,9% - 1,2% y cobalto: 1,5%. Esta mezcla da lugar al acero VG-10 y sus propiedades son inusuales, lo que le conlleva a tener mucha resistencia al desgaste y por lo tanto una gran durabilidad. Tiene una dureza de hasta 62 HRC.
- Acero inoxidable martensítico 440C: C: 1.05% Mn: 0.45% Si: 0.40% Cr: 17.50% Mo: 0.70% S: <0.030%. Este tipo de Acero tiene un alto contenido en cromo y carbono, diseñado para ofrecer una alta resistencia al desgaste y a la oxidación en ambientes húmedos. Alcanza durezas cercanas a 60 HRC y ofrece una buena retención del filo. Dureza: 59-61 HRC.

TAMAÑO DE TIJERAS

El tamaño de las tijeras se mide generalmente en pulgadas. Las cortas son 4,5 pulgadas, y las más largas llegan hasta 8 pulgadas aproximadamente. Las tijeras se miden desde la punta hasta el mango más largo, excluyendo el apoyo del dedo desmontable o permanente.

El tamaño se selecciona dependiendo de la técnica de corte. Tijeras más cortas son más adecuadas para el trabajo detallado, tijeras largas son más adecuadas para trabajos de gran alcance. Las tijeras de tamaño 5,0" (13cm), 5,5" (14cm), 6,0" (15cm) y 6,5" (16cm) son las más utilizadas por los profesionales.

TIPOS DE TIJERAS Y MANGOS

Los tipos que podemos encontrar son:

- Tijera de corte filo navaja: Tiene las dos hojas rectas, ideales para desfilados.
- Tijera de vaciar o esculpir: se componen de una hoja dentada y otra con filo, ideales para el vaciado proporcional del cabello.
- Tijera de corte con micro dentado: son aquellas que tienen en una o en las dos hojas una micro-sierra, ideales para que el cabello no resbale en el momento del corte.
- Tijeras de entresacar: las dos hojas son dentadas o de peine, ideales para entresacar cabello logrando disminuir el volumen o marcar capas sin perder el largo.

Industrias Oriol presents its line of high quality scissors. Designed to favor the professional's work thanks to its precision edge, resistant to great wear, with a finish in manual manufacturing to obtain the highest quality and precision.

MATERIAL PROPERTIES

- VG-10, the highest quality stainless steel, a Japanese material with a high concentration of coal. It offers a great resistance to corrosion and a greater ability to retain the edge. About the composition: coal: 1,05 - 1,5%, manganese: 0,5%, chromium: 14,5 - 15,5%, vanadium: 0,1 - 0,3%, molybdenum: 0,9 - 1,2% and cobalt: 1,5%. These mixtures produce the VG-10 stainless steel with the unusual properties mentioned. Great wear resistance, durability and a hardness of up to 62 HRC.
- Martensitic stainless steel 440C: C: 1.05 % Mn: 0.45% Si: 0.40 % Cr: 17.50% Mo: 0.70% S: <0.030%. This type of steel has a high content in chrome and carbon, designed to offer a high resistance to wear and to oxidation in humid environments. Reaches hardness close to 60 HRC and offers good blade retention. Hardness: 59-61 HRC.

SIZE OF THE SCISSORS

The size of the scissors is generally measured in inches. The short ones are 4.5 inches and the longest ones go up to approximately 8 inches. The scissors are measured from the tip to the longest handle, excluding the detachable or permanent finger rest.

The size is selected depending on the cutting technique. Shorter scissors are more appropriate for detailed work, longer scissors are more appropriate for tasks of broad scope. 5.0" (13cm), 5.5" (14cm), 6.0" (15cm) and 6.5" (16cm) sized scissors are mostly used by professionals.

TYPES OF SCISSORS AND HANDLES

The types we can find are:

- Razor edge cutting scissors: its two blades are straight, ideal for trimming hair diagonally.
- Thinner and texturizer scissors: made up of one sharp blade and another one with teeth on the edge of the blade, ideal for a proportional hair thinning.
- Micro-serrated teeth of thinning scissors: those that have micro-serrated blades, perfect for avoiding hair to slip in the moment of the cut.
- Thinning scissors: double serrated or comb blades perfect for thinning hair achieving volume decrease or structuring layers without losing the hair length.



4.5"

REF.06281

Mango opuesto, básico o simétrico

Opposite handle, basic or symmetrical



5.5"

REF. 04629

Mango semi offset o semi compensado

Semi offset or semi offset handle



5.5"

REF. 04630

Mango offset o compensado

Offset or compensated handle



Tijera barbero ROOSTER
ROOSTER barber scissors

Material: acero japonés 440C
 Dureza: 59-61 HRC

Material: 440C Japanese steel
 Toughness: 59-61 HRC

u.m.vta: 1  10

REF.06958 Corte
 Cutting

REF.06959 Corte
 Cutting

REF.06960 Esculpir
 Thinning

REF.06958/71 Corte
 Cutting

REF.06959/71 Corte
 Cutting

REF.06960/71 Esculpir
 Thinning

RAGNAR
 BARBER LINE

6,5"



7"



6,5"



6,5"



7"



6,5"



Tijera barbero GLORIOUS
GLORIOUS barber scissors

Material: acero japonés 440C
 Dureza: 59-61 HRC

Material: 440C Japanese steel
 Toughness: 59-61 HRC

u.m.vta: 1  10

REF.06967 Corte
 Cutting

REF.06968 Corte
 Cutting

REF.06969 Esculpir
 Thinning

6,5"



7"



6,5"





Tijera barbero LEFT DOMINANT (ZURDOS)
LEFT DOMINANT barber scissors (LEFT HANDED)

Material: acero japonés 440C
 Dureza: 59-61 HRC

Material: 440C Japanese steel
 Toughness: 59-61 HRC

u.m.vta: 1  10

REF.06979 Corte
 Cutting

6,5"

REF.06980 Corte
 Cutting

7"

REF.06981 Esculpir
 Thinning

6,5"

REF.06979/71 Corte
 Cutting

6,5"

REF.06980/71 Corte
 Cutting

7"

REF.06981/71 Esculpir
 Thinning

6,5"

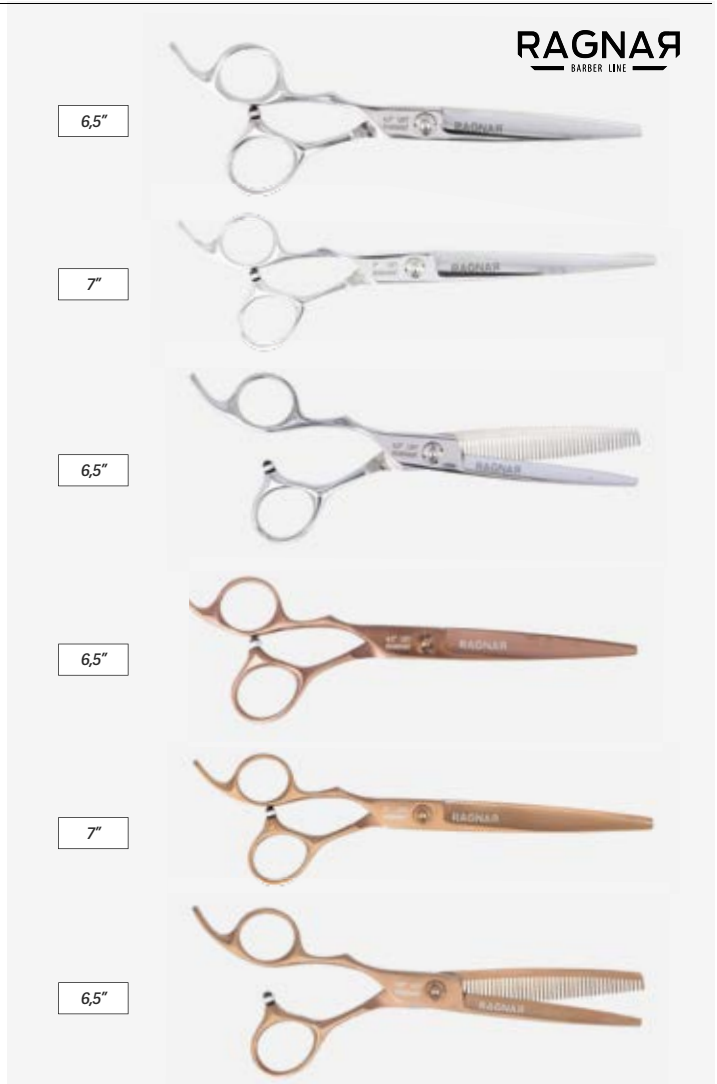



Tijera barbero BLACK PEARL
BLACK PEARL barber scissors

u.m.vta: 1 10

REF.06392

Corte
Cutting



REF.06393

Esculpir
32 dientes oblicuo

Thinning
32 teeth oblique

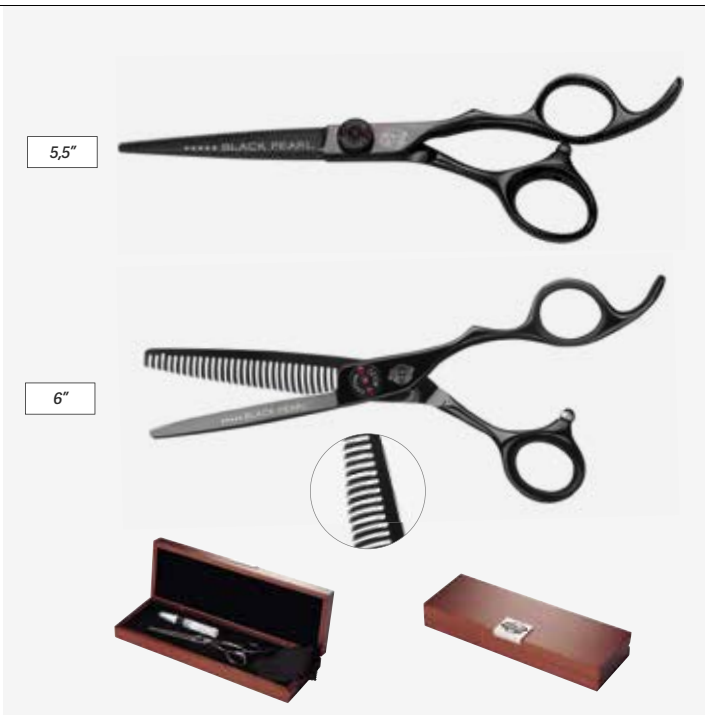

- Material: acero japonés 440C
 - Cuerpo: titanio negro
 - Tornillo: ajuste del dedo con rodamiento de bolas
 - Dureza: 62 HRC
 - Mango: offset
- Material: 440C Japanese steel
 - Body: black titanium
 - Screw: finger adjust with ball-bearing
 - Toughness: 62 HRC
 - Handle: offset

u.m.vta: 1 10

REF.04895

Corte
Cutting



REF.04896

Esculpir
50 dientes

Thinning
50 teeth



- Material: acero 440C
 - Dureza: 60HRC
 - Borde: convexo
- Material: 440C steel
 - Toughness: 60HRC
 - Edge: convexo

Tijera barbero **BLACK PEARL** **BLACK PEARL** barber scissors

u.m.vta: 1  10

REF.06394

Esculpir
32 dientes oblicuoThinning
32 teeth oblique

- Material: acero japonés 440C
- Cuerpo: titanio negro
- Tornillo: ajuste del dedo con rodamiento de bolas
- Dureza: 62 HRC
- Mango: offset

- Material: 440C Japanese steel
- Body: black titanium
- Screw: Finger adjust with ball-bearing
- Toughness: 62HRC
- Handle: offset

Tijera barbero **BLACK RIPPER** **BLACK RIPPER** barber scissors

u.m.vta: 1  10

REF.06478

Esculpir
Thinning

REF.06479

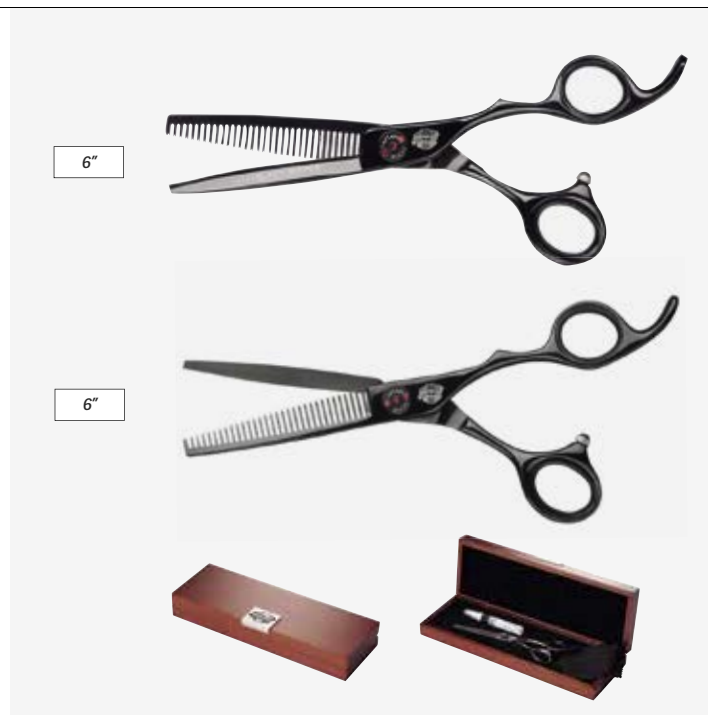
Esculpir
Thinning

Acero Japonés 440C. Sus hojas han sido fabricadas con un grado superior de afilado, lo que las convierte en idóneas para todo tipo de corte, con cabello húmedo o seco. Estas tijeras son de diseño atrevido y moderno pero sin desentonar con el estilo "old School". 32 dientes rectos.

440C Japanese steel. Its blades have been manufactured with a superior degree of sharpening, which makes them ideal for all types of cutting, with wet or dry hair. These scissors are bold and modern design but without clashing with the "old School" style. 32 straight teeth.



Tijera barbero SILVER DIAMOND

SILVER DIAMOND barber scissors

u.m.vta: 1  10

REF.04897

Corte
Cutting

8"



- Material: acero japonés 440C
- Cuerpo: titanio
- Tornillo: ajuste del dedo con rodamiento de bolas
- Dureza: 62HRC
- Borde: convexo
- Mango: offset

- Material: 440C Japanese steel
- Body: black titanium
- Screw: finger adjust with ball-bearing
- Toughness: 62HRC
- Edge: convexo
- Handle: offset

Tijera barbero BLACK QUEEN

BLACK QUEEN barber scissors

u.m.vta: 1  10

REF.06961

- Agarradera con rotatoria
- With rotating handle

6,5"



Material: Acero japonés 440C
Dureza: 59-61 HRC

Material: 440C Japanese steel
Toughness: 59-61 HRC

Tijera barbero LEGEND

LEGEND barber scissors

u.m.vta: 1  10

REF.06962

Corte
Cutting

6,5"



REF.06963

Esculpir
Thinning

6,5"



Material: acero japonés 440C
Dureza: 59-61 HRC

Material: 440C Japanese steel
Toughness: 59-61 HRC

Tijera barbero NEPTUNO

NEPTUNO barber scissors

Barber Line

u.m.vta: 1  10 

REF. 04625 Corte
Cutting

6,5"



6,5"



REF. 04626 Esculpir
Thinning

- Acero 440
- Afilado navaja
- Acabado manual
- Gran dureza 59,61 HRC
- Tornillos de ajuste
- Estuche individual

- 440 steel
- Razor sharpened
- Hand-finished
- High level of hardness: 59.61 HRC
- Adjustment screws
- Individual pouch

Tijera barbero BARBER LINE

BARBER LINE barber scissors

u.m.vta: 1  10



REF.04899 Corte
Cutting

- Material: acero 440C
- Dureza: 60 HRC
- Borde: convexo

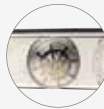

- Material: 440C steel
- Toughness: 60 HRC
- Edge: convexo

7,5"

u.m.vta: 1  12

REF.06281 Corte
Cutting

4,5"



• Ideal para retocar la barba

• Ideal for retouching the beard

Tijera PIRATA

PIRATA scissors

u.m.vta: 1  10 

REF. 04630 Corte
Cutting

5,5"



Tijera corte acero WAVES

WAVES steel cutting scissors

u.m.vta: 1	12
------------	----

REF.04316 Corte
Cutting

6"



REF.04317 Esculpir
Thinning

5,75"



Tijera profesional ERGO

ERGO professional scissors

u.m.vta: 1	12
------------	----

REF.04314 Corte
Cutting

6"



REF.04315 Esculpir
Thinning

6"



Tijera filo navaja negra mango dorado
Black scissors edge razor with golden handle

u.m.vta: 1  12

REF.04499 Corte
 Cutting

REF.04500 Esculpir
 Thinning



Tijera filo navaja negra mate
Matte black scissors edge razor

u.m.vta: 1  12

REF.04501 Corte
 Cutting

REF.04502 Esculpir
 Thinning



Tijeras INICIACIÓN

INITIATION scissors

u.m.vta: 1  12

REF.04359

Corte
Cutting



u.m.vta: 1  12

REF.04361

Esculpir
Thinning



kit corte estudiantes

Cutting kit for students

u.m.vta: 1  50

REF.04901

- 1 tijera corte
- 1 tijera esculpir
- 1 navaja metálica

- 1 cutting scissors
- 1 thinning scissors
- 1 metallic razor



Tijera profesional especial ZURDOS
Special LEFT HANDED professional scissors

u.m.vta: 1  30

REF.02213

Corte
Cutting



Tijera filo navaja ZURDOS MAT
MATT LEFT HANDED razor edge scissors

u.m.vta: 1  12

REF.04503

Corte
Cutting

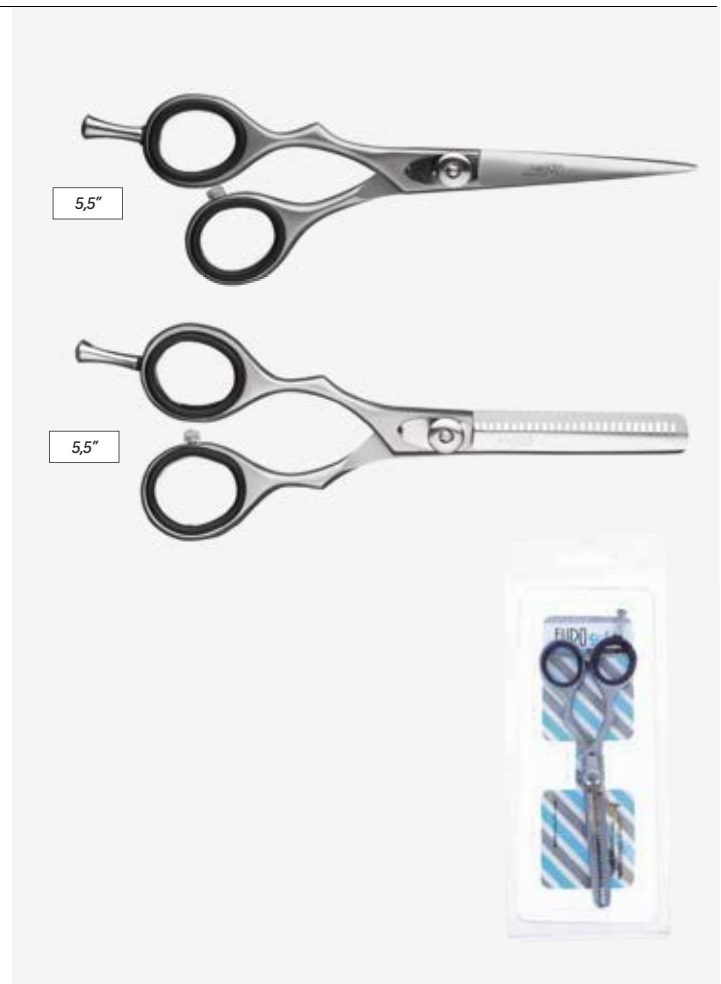

REF.04504

Esculpir
Thinning



04

Cepillos y brochas Barber & Shaving brushes

*Brochas y cepillos de barbería,
talcos barbería...*

*Barber and shaving brushes,
barber talcs...*

Cepillo barbero NYLON con depósito para talco
NYLON barber brush with talc tank

u.m.vta: 6  36



REF.01463

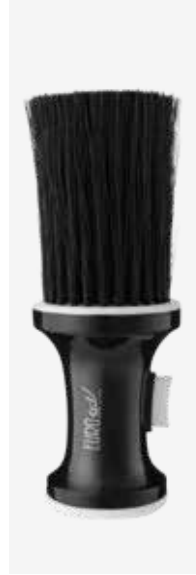

u.m.vta: 6  60

REF.01463/50



u.m.vta: 1  6 

REF. 00788





Cepillo barbero de nylon
Nylon Barber brush

u.m.vta: 1  6 

REF. 03403





u.m.vta: 1  20 

REF. 01412



Cepillo barbero mango madera
Wooden handle barber brush

u.m.vta: 1  12 

REF. 00336



Brochas de afeitar

Shaving brushes

RAGNAR
 BARBER LINE
u.m.vta: 1  7 

Ø 21

REF. 07810

Ø 21

Ø 24



- Púas de pelo natural
- Caballo, pelo marrón

- Natural hair bristles
- Horse, brown hair

REF. 04372

Ø 24



- Púas de pelo natural de pony

- Pony natural hair bristles

Ø 24

REF. 07811

Brochas vintage de afeitar

Shaving vintage brushes

u.m.vta: 1  20

S

REF.00644

- Las Púas de la brocha son de pelo natural de cerdo (hervidas con cloro para aclarar el color)
- Púas de 5 cm aprox. de largo
- Mango de madera y metal

- The bristles on this brush are natural pig hair (boiled in chloride to lighten their colour)
- Bristles approximately 50 mm long
- Wood and metal handle

L

REF.00645



Bacia jabón afeitado

Bowl for shaving soap



u.m.vta: 1  4

REF.04255



Botella talco cepillo Spartal 280g

Talc brush bottle Spartal 280g

u.m.vta: 1  6 

280 g

REF. 01293

RAGNAR
BARBER LINE



Talco RAGNAR

RAGNAR talc

u.m.vta: 1  6 

200 g

REF. 06428



- Absorbe la humedad
- Mantiene la piel fresca y seca
- Alivia la piel irritada
- Suaviza
- Sin alérgenos & parabenos, testado dermatológicamente
- MODO DE EMPLEO: espolvorear en las manos o en la brocha y aplicar tantas veces como sea necesario

- *Moisture absorption*
- *Keeps the skin cool and dry*
- *Avoids skin irritations*
- *Softens*
- *Without allergens & parabens, dermatologically tested*
- *HOW TO USE: sprinkle on hands or brush and apply as many times as necessary*



Lata de talco perfumado

Can of perfumed talc

u.m.vta: 1  9 

300 g

REF. 06437

- Absorbe la humedad
- Mantiene la piel fresca y seca
- Alivia la piel irritada y suaviza
- Sin parabenos ni alérgenos
- Packaging novedoso y respetuoso con el medio ambiente
- Con aroma masculino
- Envase innovador

- *Absorbs moisture*
- *Keeps skin fresh and dry*
- *Soothes irritated skin and softens*
- *No parabens or allergens*
- *New packaging respectful with the environment*
- *With masculine scent*
- *New innovative packaging*



Más
información
More
information

SCAN
ME!



Set de afeitado para hombres Barber shaving set for men

Barber Line

u.m.vta: 1  24



REF.06177

Set de afeitado clásico para hombres sibaritas que no quieren renunciar al placer del afeitado a la antigua usanza. Contiene una navaja para un rasurado preciso, una brocha ergonómica que le aportará confort y una bacía, utensilio indispensable para cualquier barbero. Aféitese a la antigua usanza y consiga un afeitado perfecto y preciso en tan solo unos minutos.

Classic shaving set for gourmet men who do not want to give up the pleasure of shaving in the traditional style. It contains a razor for precise shaving, an ergonomic brush that will provide comfort and a bowl, a must-have tool for any barber. Shave in the traditional way and get a perfect and precise shaving in just a few minutes.



Peine especial barba Special beard comb

u.m.vta: 1  12 

REF.06176



Cepillo barba Ragnar pequeño y grande Small and large Ragnar beard brush

u.m.vta: 1  20 

REF.07285

RAGNAR
BARBER LINE

NEW



REF.07286

Cepillo cuello RAGNAR de madera

Wooden RAGNAR neck brush

u.m.vta: 1  14 

REF. 06070

Cepillo barbero RAGNAR. Púas de nylon pulidas. Gran suavidad y poder de arrastre. Ideal para quitar el pelo cortado de cuello y nuca.

RAGNAR barber brush. Nylon bristles polished. Great softness and drag power. Ideal to remove the cut hair from the neck and nape.



Cepillo TRITÓN

TRITON brush

u.m.vta: 1  12 

REF. 06076



El diseño de este cepillo está concebido para arrastrar los restos de pelos que quedan en la nuca después de cada corte. El cepillo TRITON está fabricado 100% con madera natural mientras que sus púas son 100% sintéticas. Sus púas suaves arrastran los restos de cabellos sin rascar.

This brush has been designed to catch any loose hair on the back of the neck after a haircut. The TRITON brush is made from 100% natural wood, whereas its bristles are 100% synthetic. Its soft bristles gently catch the hair without scratching.



Cepillo cuello barbero púas pulidas

Brush barber neck polished bristles

u.m.vta: 1  18 

REF.06116

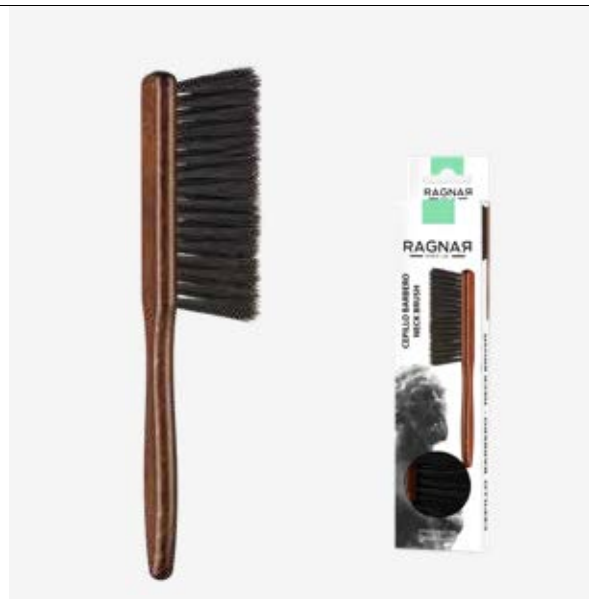

Cepillo de barbero de madera RAGNAR. Con púas de nylon, que aportan gran suavidad y poder de arrastre. Ideal para quitar el pelo cortado de cuello y nuca.

RAGNAR wooden barber brush. With nylon bristles, which provide great softness and drag power. Ideal to remove hair cut off neck and nape.



Cepillo barbero POSEIDÓN

POSEIDON barber brush

u.m.vta: 1  12 

REF. 06078

Su diseño redondeado se adapta perfectamente a la palma de la mano permitiendo peinar la barba cómodamente. El cepillo POSEIDÓN está fabricado 100% con madera natural. Sus púas, 50% naturales y 50% nylon, proporcionan ese toque de suavidad que la púa natural no ofrece.

Its round design adapts perfectly to the palm of your hand, allowing you to brush the beard comfortably. The POSEIDON brush is made from 100% natural wood. Its bristles, 50% natural and 50% nylon, offer that extra softness that natural bristles cannot achieve.





10 cm



Cepillo barbero TALASA

TALASA barber brush

u.m.vta: 1  12 

REF. 06073

Este cepillo de tamaño reducido sin mango y forma redondeada es perfecto para aquellas barbas cortas. Su reducido tamaño nos permite llegar a esas zonas difíciles de peinar como la zona del bigote. El cepillo TALASA está fabricado 100% con madera natural. Sus púas, 50% naturales y 50% nylon, proporcionan ese toque de suavidad que la púa natural no ofrece.

This round and small-sized brush without a handle is perfect for short beards. Its small size enables you to reach those hard-to-brush areas, like the moustache area. The TALASA brush is made from 100% natural wood. Its bristles, 50% natural and 50% nylon, offer that extra softness that natural bristles cannot achieve.



8 cm



Cepillo barbero APOLO

APOLO barber brush

u.m.vta: 1  12 

REF. 06077

El diseño de este cepillo está pensado para aquellas barbas densas y difíciles de peinar. Su tamaño ancho permite cepillar zonas amplias y densas de nuestra barba. El cepillo APOLO está fabricado 100% con madera natural. Sus púas 50% naturales y 50% nylon proporcionan ese toque de suavidad que la púa natural no ofrece.

This brush has been designed for dense and hard-to-brush beards. Its wideness allows brushing large and untameable areas of our beard. The APOLO brush is made from 100% natural wood. Its bristles are 50% natural material and 50% nylon to give you that extra softness that natural bristles cannot achieve.





15 cm



Cepillo barbero OCEÁNO

OCEANO barber brush

u.m.vta: 1  12 

REF. 06075

El diseño de este cepillo está concebido para el cuidado del cabello y de la barba. El cepillo OCEANO está fabricado 100% con madera natural. Sus púas 50% naturales y 50% nylon proporcionan ese toque de suavidad que la púa natural no ofrece.

This brush has been designed to care for hair and beards. The OCEANO brush is made from 100% natural wood. Its bristles are 50% natural material and 50% nylon to give you that extra softness that natural bristles cannot achieve.





20 cm



Cepillo barbero NEREO de madera

NEREO wooden barber brush

u.m.vta: 1  12 

REF. 06072



Este cepillo de tamaño reducido provisto de un mango de madera, es perfecto para las barbas cortas. Su mango permite peinar zonas pequeñas como el bigote. El cepillo NEREO está fabricado 100% con madera natural. Sus púas 50% naturales y 50% nylon proporcionan ese toque de suavidad que la púa natural no ofrece.

This small-sized beard brush with a handle is perfect for short beards. Its handle allows you to brush small areas like the moustache. The NEREO brush is made from 100% natural wood. Its bristles are 50% natural material and 50% nylon to give you that extra softness that natural bristles cannot achieve.



Cepillo ropa GORGONAS

GORGONAS clothes brush

u.m.vta: 1  12 

REF. 06074



Este cepillo ha sido diseñado para retirar los restos de cabello que quedan atrapados en la ropa después del corte. El cepillo GORGONAS está fabricado 100% con madera natural y sus púas son 100% de nylon. Sus púas resistentes arrastran los pelos y la suciedad dejando la ropa limpia. Su mando ergonómico permite una sujeción cómoda del cepillo mientras se trabaja.

This brush has been designed to remove hair that may have fallen onto the clothes after haircut. The GORGONAS brush is made from 100% natural wood, and its bristles are 100% nylon. Its resistant bristles collect hair and dirt, leaving the clothes clean. Its ergonomic handle allows a comfortable grip while working with the brush.



Cepillo Fade: para degradado de barbería

Fade brush: for barber degradate

u.m.vta: 1  24 



REF. 04976

Cepillo de plástico con púas de nylon suaves ideal para los cortes "Fade"
Plastic brush with soft nylon bristles ideal for "Fade" cuts



Cepillo cuello barbero

Barber neck brush

u.m.vta: 4  40 

REF. 00501



- Mango plástico
- Púas: nylon

- Plastic handle
- Bristles: nylon



EUROSTIL
PROFESSIONAL

u.m.vta: 1  18 

REF. 00595



- Mango madera
- Púas: nylon

- Wooden handle
- Bristles: nylon



Cepillo de barbero grande

Large barber brush

u.m.vta: 1  14 

REF. 00306



- Mango plástico
- Púas: nylon

- Plastic handle
- Bristles: nylon



Cepillo plano puro jabalí

Flat brush pure boar

u.m.vta: 1  12 

REF.00599



- Pelo natural de jabalí

- Natural wild boar hair



Cepillo de fuelle con mango de madera jabalí

Cushion wooden handle boar

u.m.vta: 1  12 

REF. 00352



- Mango de madera
- Pelo natural de jabalí

- Wooden handle
- Natural wild boar hair



Cepillo curvo esqueleto

Curved vent brushe

u.m.vta: 12  96 

REF. 02195/50

- Púas de plástico con bola
- Plastic bristles with ball



Cepillo esqueleto antiestático
Antistatic vent brush



u.m.vta: 1	12	
------------	----	--

REF.00584

- Púas de nylon con bola
- Nylon bristles with ball



Cepillos dobles esqueleto
Double vent brushes

u.m.vta: 24	24	
-------------	----	--



REF. 02182



REF. 02182/50

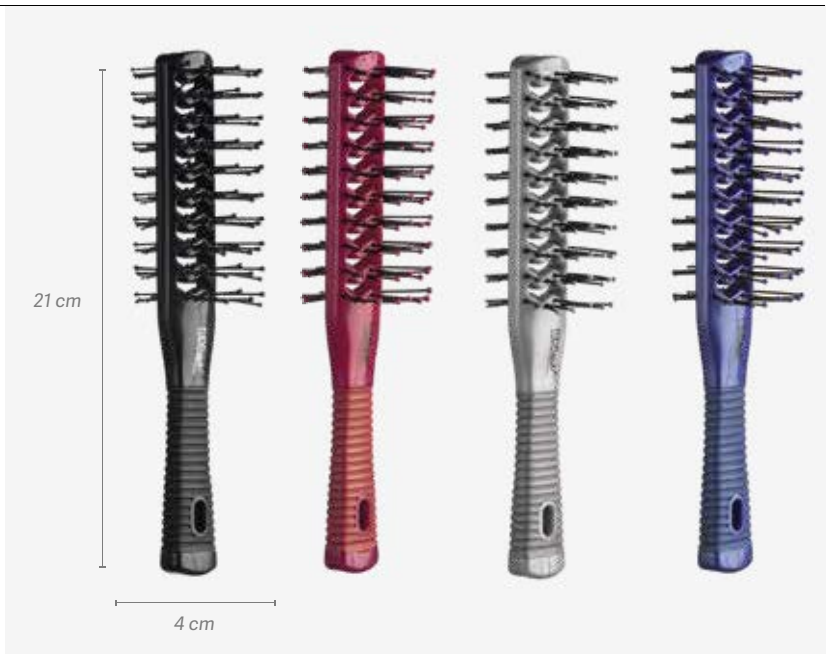

Cepillo Fade: para degradado de barbería
Fade brush: for barber degradate

u.m.vta: 1	24	
------------	----	--

REF. 04977

Cepillo de plástico con púas de nylon suaves ideal para los cortes "Fade"
 Plastic brush with soft nylon bristles ideal for "Fade" cuts







05

Peines Combs

Peines Barber Line, peines Captain Cook, peines Eurostil, peines Silkomb...

Barber Line combs, Captain Cook combs, Eurostil combs, Silkomb combs...

Peine barbero corte
Cutting barber comb

u.m.vta: 12  72 



Negro
Black

REF.07356



Marfil
Ivory

REF.07356/82



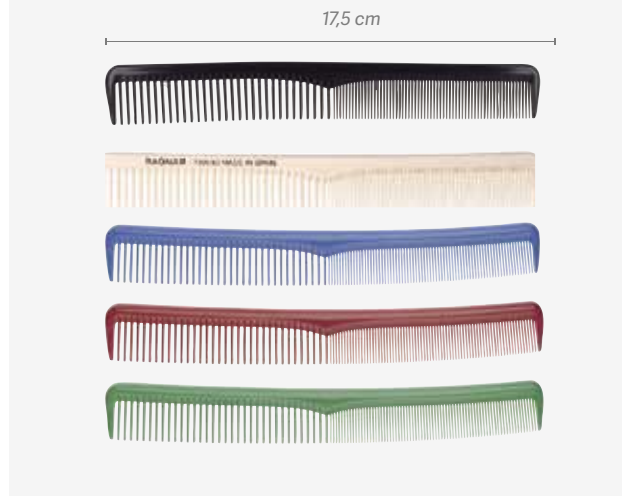

Clásico
Classic

REF.07356/98



Peine barbero
Barber comb

u.m.vta: 12  72 



Negro
Black

REF.07355



Marfil
Ivory



REF.07355/82

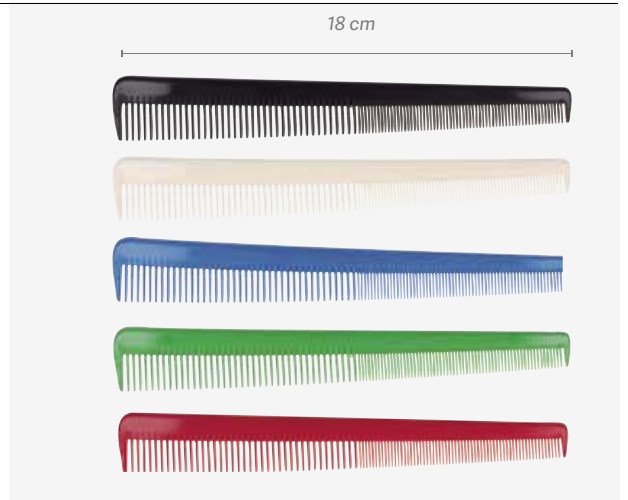

Clásico
Classic

REF.07355/98



u.m.vta: 12  72 



Negro
Black

REF.07357



Marfil
Ivory

REF.07357/82



Clásico
Classic

REF.07357/98

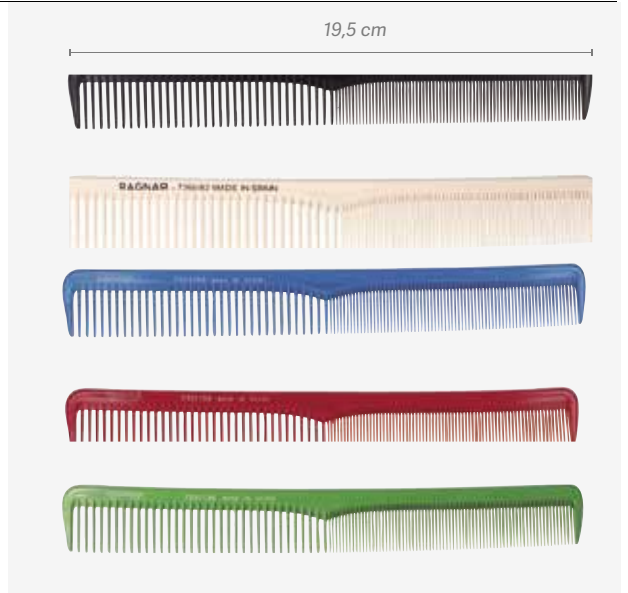

Peine barbero batidor
Cutting barber comb



u.m.vta: 12 72

- | | | |
|------------------------------|-------------------------------|----------------------------------|
| ● | ● | ● ● ● |
| Negro
<i>Black</i> | Marfil
<i>Ivory</i> | Clásico
<i>Classic</i> |
| MOD. 04616 | MOD. 04616/82 | MOD. 04616/98 |
| REF.07358 | REF.07358/82 | REF.07358/98 |



u.m.vta: 12 72

- | | |
|------------------|--|
| MOD. 00113 | <ul style="list-style-type: none"> • Nylon • Negro • Nylon • Black |
| REF.07359 | |



- | | |
|------------------|---|
| MOD. 00424 | <ul style="list-style-type: none"> • Reforzado • Negro • Strenghtened • Black |
| REF.07360 | |

u.m.vta: 12 48

- | | |
|------------------|--|
| MOD. 00454 | <ul style="list-style-type: none"> • Recto • Negro • Straight comb • Black |
| REF.07361 | |



- | | |
|------------------|---|
| MOD. 00455 | <ul style="list-style-type: none"> • Mechas • Negro • Streak comb • Black |
| REF.07362 | |

Peine carbono RAGNAR
RAGNAR carbon comb



u.m.vta: 12 72

MOD. 02216

- Batidor / Grande
- Cutting comb / Big

REF.07367

MOD. 02215

- Especial
- Special

REF.07368



Peine barbero corte especial
Special cutting barber comb

u.m.vta: 12 60

MOD. 02183

- Peine corte especial máquina profesional
- Special cutting comb professional machine

REF.07363

MOD. 06802

REF.07364



MOD. 06802/82

- Peine corte especial máquina profesional
- Special cutting comb professional machine

REF.07364/82





Peine barbero ahuecador Styling barber comb

u.m.vta: 12  60 

MOD. 00419/50 • Negro
• Black
REF.07365/50



Peine mechas Streak comb

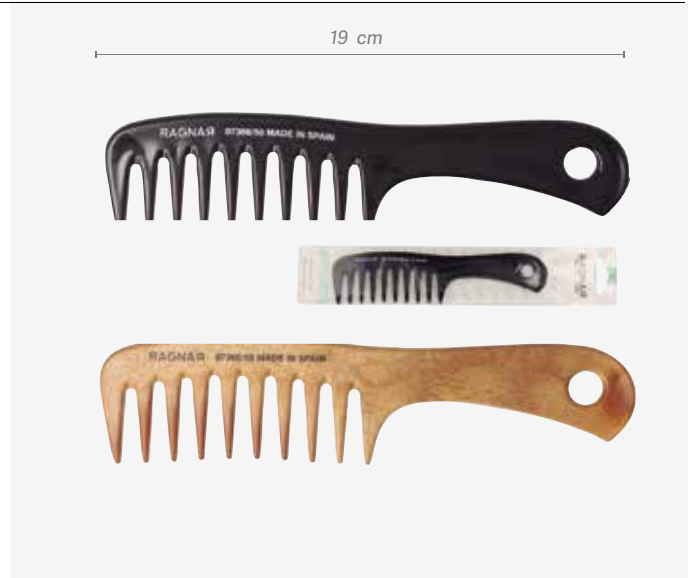

u.m.vta: 12  48 

MOD. 00409/50 • Negro
• Black
REF.07366/50



MOD. 00409 • Madera
• Wood
REF.07366/55

Peine mechas Streak comb

u.m.vta: 12  48 

REF.07602 • Doble púa
• Double pin



Línea peines CAPTAIN COOK
CAPTAIN COOK comb



u.m.vta: 12 72

REF. 04981

- Carbono
- Carbon



REF.07441

- Negro
- Black

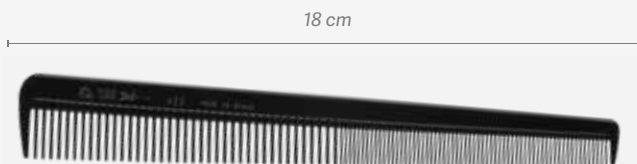

REF.07441/82

- Marfil
- Ivory



u.m.vta: 12 72

REF.07442

- Negro
- Black

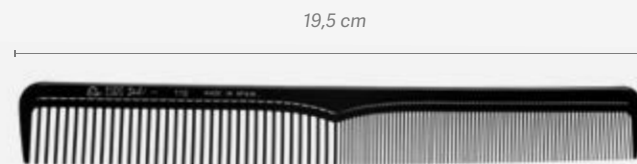

REF.07442/82

- Marfil
- Ivory





Línea peines CAPTAIN COOK
CAPTAIN COOK comb

u.m.vta: 12 60

REF.07443



REF.07443/82

- Mechas / Negro
- Streak comb - Black

u.m.vta: 12 48

REF.07444



u.m.vta: 12 60

REF.07474

NEW



REF.07474/82



Peine madera barba-bigote
Wooden beard-moustache comb

u.m.vta: 12 60

REF.04548

- Ancho
- Wide

ESPECIAL BARBA & BIGOTE
SPECIAL BEARD AND MUSTACHE



u.m.vta: 12 96

REF.04549

- Con mango
- With handle



Peine concha barba-bigote
Tortoise beard-moustache comb

u.m.vta: 12 120

REF.04546

- Mango largo
- Long handle



REF.04547

- Mango largo
- Long handle



u.m.vta: 12 96

REF.04545

- Plegable
- Folding comb



Peine batidor profesional Eurostil Eurostil professional cutting comb

u.m.vta: 12 72



REF. 00115

- Púa especial
- Special pin

17,5 cm



REF. 00442

- Púa especial
- Special pin

17,5 cm

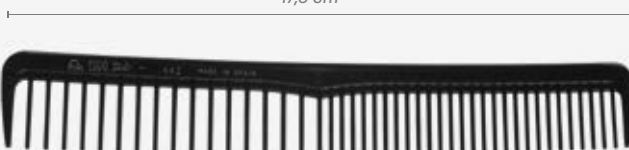

REF. 00441

- Púa especial
- Special pin

17,5 cm

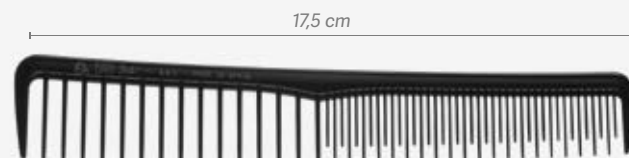

REF. 00424

- Especial reforzado
- Strengthened

18,5 cm



REF. 00116

- Grande
- Large

19,5 cm



REF. 01470

- Super largo
- Extralong

21,5 cm



Peine especial peluquero Special hairdresser comb



REF. 00422





REF. 00422/58

18 cm



Peines carbono Carbon combs

u.m.vta: 12	 72	
-------------	--	---

REF. 02186

- Batidor corte
- Cutting comb

17,5 cm

**REF. 02214**

- Púa especial
- Special pin

17,5 cm

**REF. 02215**

- Especial peluquero
- Special hairdresser



18 cm

**REF. 02216**

- Batidor corte
- Cutting comb

19,5 cm





u.m.vta: 12	 48	
-------------	--	---

REF. 02188

- Mod. RECTO
- Straight mod.

19,5 cm



u.m.vta: 12	 72	
-------------	--	---

REF. 02187

- Púa especial
- Special pin

20,5 cm



Peine profesional SILKOMB SILKOMB professional comb



u.m.vta: 1 50

PRO-10

REF. 01520



PRO-40

REF. 01524

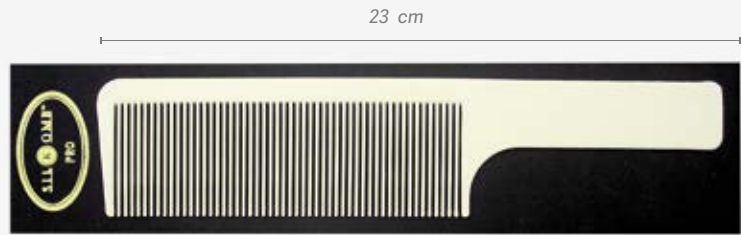

PRO-50

REF. 01525



PRO-20

REF. 01522



PRO-30

REF. 01523

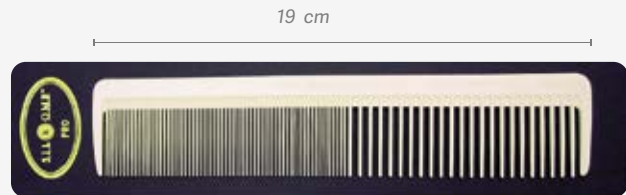



PRO-11

REF. 01521



Peine con niveles Comb with levels



u.m.vta: 1  120 

REF. 04349



- Peine con niveles
- Permite realizar un corte o escalado en línea recta perfecta gracias a sus 3 niveles
- Cutting comb with levels
- It allows you to make a cut or scale in a perfect straight line thanks to its 3 levels

Cepillo limpia-peines Brush clean combs

u.m.vta: 1  100 

REF. 00600

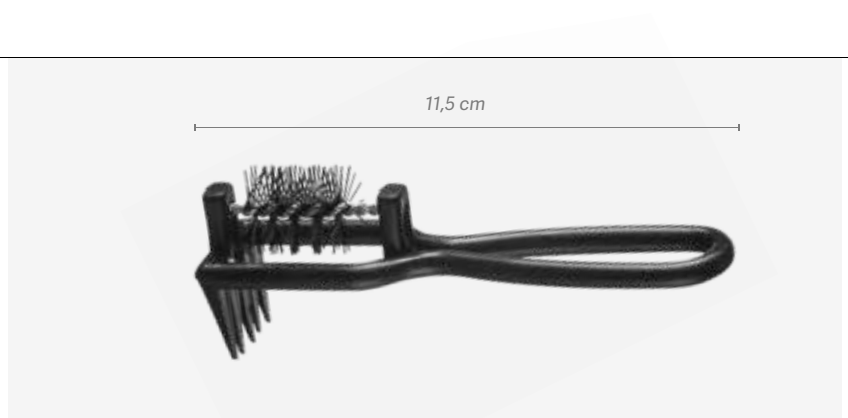

06

Cosmética Cosmetic

*Cosmética capilar, cosmética
para barba, cosmética de fijación...*

*Hair cosmetics, beard cosmetics,
fixing cosmetics...*

TASSEL
PROFESSIONAL HAIR COSMETICS

¡Gana seguridad!

Disimula la calvicie con
Fibras capilares Tassel

Win security!

Conceal baldness with
Tassel hair fibers

NEGRO - BLACK

CASTAÑO OSCURO
DARK CHESTNUT

CASTAÑO - CHESTNUT

CASTAÑO CLARO
LIGHT CHESTNUT

RUBIO OSCURO
LIGHT BLONDE

GRIS CLARO - LIGHT GREY

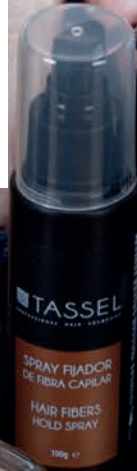

Asas before

Asas after



Retoca-raíces Ragnar 75 ml para cabello y barba

Ragnar root fixer 75 ml for hair and bear

u.m.vta: 1  12 

REF. 07475/50



• Negro
• Black

REF. 07475/65



• Castaño claro
• Light brown

REF. 07475/67



• Castaño oscuro
• Dark brown

- Coloración temporal en spray.
- Cubre raíces y canas al instante.
- Temporary spray dye.
- Covers roots and grey hair instantly.

Expositor retoca-raíces Ragnar

Ragnar root touch up display

u.m.vta: 1  1

REF. 07582

Vacío
Empty
REF. 07582/01





Champú para el cuero cabelludo sensible



Sensitive scalp shampoo

u.m.vta: 1  4250 ml 

REF. 04963

u.m.vta: 1  2 500 ml 

REF. 07374

u.m.vta: 1  6 1L 

REF. 07375



Regulador del cuero cabelludo

Con agentes tensioactivos suaves y con gran poder de humectación, por lo que baja la tensión superficial del agua. Por sus activos, tiene propiedades acondicionadoras del cabello para que sea más fácil el peinado, aporta humedad para superar la sensación de sequedad y fragilidad, controla la producción de células muertas en el cuero cabelludo y ejerce actividad antibacteriana y antimicótica. Ideal para cabellos y cueros cabelludos sensibles.

Scalp regulator



With soft acting foaming agents and great moisturising power, it reduces the superficial tension of the water. Its active ingredients provide it with the following properties: it conditions the hairmaking it easier to brush, it provides moisture to overcome the sensation of dryness and fragility, it controls the production of dead cells on the scalp and it exercises an antibacterial and antifungal activity. Ideal for sensitive hair and scalp.

Champú silver para cabellos grises



Silver shampoo for grey hair

u.m.vta: 1  4250 ml 

REF. 04965

u.m.vta: 1  2 500 ml 

REF. 07376

u.m.vta: 1  6 1L 

REF. 07377

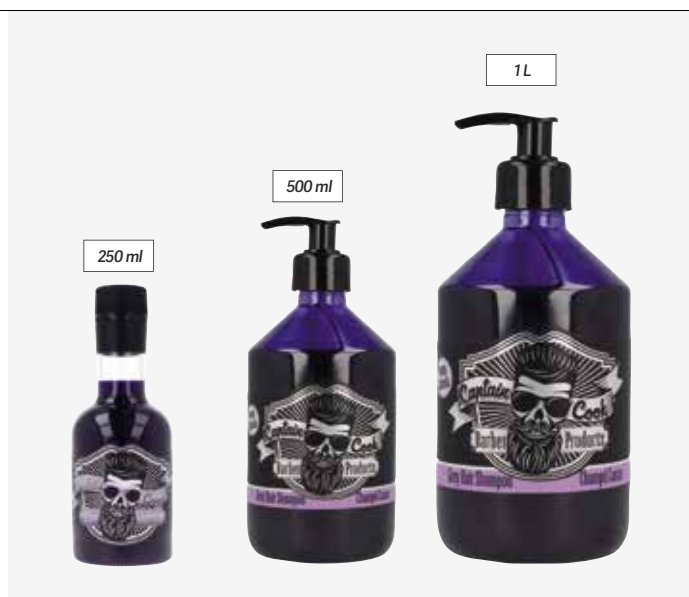





Para cabellos grises

Con agentes tensioactivos suaves y con gran poder de humectación, por lo que baja la tensión superficial del agua. Por sus activos, acondiciona el cabello para que sea más fácil el peinado y con pigmentos de origen vegetal que previenen el cambio de color en los cabellos canosos reavivando el brillo. Especial para cabellos canosos, evitando y cubriendo el tono amarillento.

For grey hair

With soft acting foaming agents and great moisturising power, it reduces the superficial tension of the water. Its active ingredients condition the hair to make it easier to brush, and its vegetable based pigments prevent the change of colour in grey hairs revitalising the shine. Specially designed for grey hair, preventing and covering yellow tones.

Champú refrescante Refreshing shampoo

u.m.vta: 1		2		u.m.vta: 1		6	
------------	---	---	---	------------	---	---	---

500 ml	PH 5.5	1L	PH 5.5
--------	--------	----	--------

REF. 07370

REF. 07371

Especialmente indicado para prevenir y combatir la caída del cabello, estimulando el cuero cabelludo y aportando una renovada vitalidad. Reduce el sebo devolviendo al cabello su brillo natural.

Especially indicated to prevent and combat hair loss as it stimulates the scalp, providing it with renewed vitality. It also reduces oiliness, providing hair with its original shine.







Crema suavizante Conditioner cream

u.m.vta: 1		4
------------	---	---

250 ml	PH 5.5
--------	--------

REF. 04870

u.m.vta: 1		2		u.m.vta: 1		6	
------------	---	---	---	------------	---	---	---

500 ml	PH 5.5	1L	PH 5.5
--------	--------	----	--------

REF. 07372

REF. 07373





Complemento del champú. Incorpora propiedades refrescantes y estimulantes del cuero cabelludo devolviendo su hidratación y brillo natural.

Acts as a complement to the shampoo. It boasts refreshing and stimulating properties that return its natural hydration and shine to the scalp.



Pomada de modelaje para fijación suave

Soft hold hair pomade



u.m.vta: 1  6 

200 ml

100 ml

REF. 04867

REF.06232

u.m.vta: 1  16 

50 ml

REF.06233



Ideal para estilos exigentes que quieran tener un aspecto perfecto. Proporcionando brillo y una fijación suave y flexible sin dejar residuos. De base agua, por lo que aporta suavidad e hidratación al cabello.

Ideal for demanding styles that require a perfect look. This pomade will give you shine and a soft and flexible hold without leaving any residue. It is water-based and therefore provides softness and hydration to your hair.

Pomada de modelaje para fijación media

Medium hold hair pomade



u.m.vta: 1  6 

200 ml

100 ml

REF. 06229

REF.06230

u.m.vta: 1  16 

50 ml



REF.06231



Cera en crema de fácil aplicación para mantener y definir el peinado deseado. Con ceras naturales y manteca de Karité que protegen y cuidan al cabello. Acabado mate natural para cualquier tipo de peinado.

Easy application cream wax to maintain and define the desired hairstyle. With natural waxes and shea butter that protect and care for hair. Natural matt finish for any type of hairstyle.

Pomada de peinado para fijación fuerte Strong hold hair pomade



u.m.vta: 1  6 

200 ml

100 ml

REF. 04866

REF.06236

u.m.vta: 1  16 

50 ml

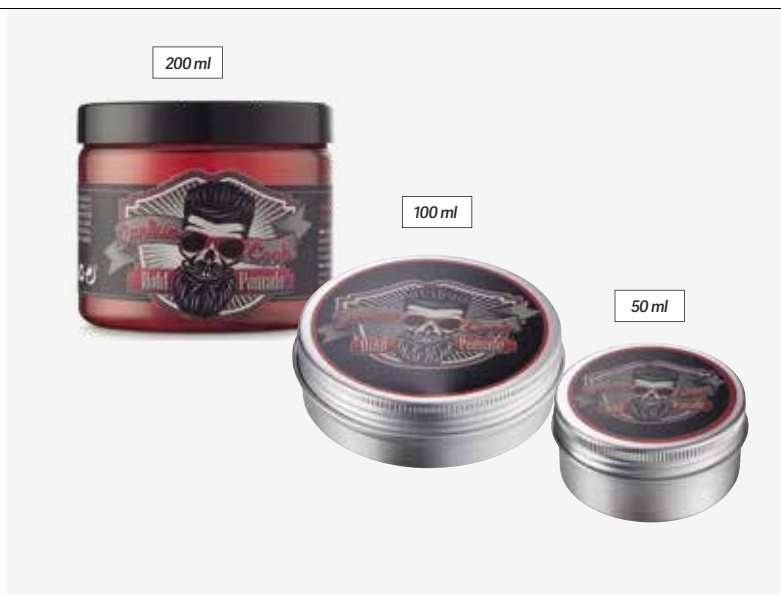

REF.06237



Proporciona brillo y fijación fuerte pero dejando el cabello flexible, de fácil eliminación sin dejar residuos. De base agua, lo que aporta suavidad e hidratación al acabado.

This pomade will provide you with a strong yet flexible hold that is easy to wash out without residue. It is water-based and therefore provides softness and hydration to your hair.

Pomada de peinado mate Rubber Matt Rubber Matt matte hair pomade



u.m.vta: 1  6 

200 ml

100 ml

REF. 04868

REF.06234

u.m.vta: 1  16 

50 ml

REF.06235





Pomada de peinado mate fijación Rubber Mate que permite dar forma y volumen al cabello consiguiendo un peinado duradero. De secado rápido y acabado mate. No deja residuos. Por su composición, rica en ceras naturales, aporta suavidad y protección al cabello.

MATTE "RUBBER HOLD" hair pomade. This pomade allows you to give shape and volume to your hair, achieving a long-lasting hairstyle. It dries quickly with a matte finish. It does not leave any residue. Due to its formula, which is rich in natural oils, it provides softness and protection to your hair.

Pomada modelaje fijación suave Spider Gum

Spider Gum Soft hold hair pomade



u.m.vta: 1  6 

200 ml

100 ml

REF. 06677

REF.06678

u.m.vta: 1  16 

50 ml

REF.06679





Cera fibrosa para moldear y texturizar el cabello. Fijación fuerte, larga duración y fácil de eliminar. Modo de aplicación: tratar una pequeña cantidad de producto entre las manos, calentarlo con la fricción de estas manos para activar las fibras y aplicar sobre el cabello, dándole la forma deseada.

Fibrous wax to mold and texturize hair. Strong fixation, long lasting and easy to remove. How to apply: put a small amount of the product between your fingers, warm it with the friction of your hands to activate the fibers and apply to the hair, giving it the desired shape.

Fijación de efecto seco Gravity Zero

Gravity Zero dry effect fixing

u.m.vta: 1  10 

125 ml

REF. 04961



Gravity Zero: gracias a su composición, deja sobre el cabello una película invisible de efecto seco con gran volumen y poder hidratante. Ideal para cualquier tipo de cabello aportando luminosidad. Potente incluso con alta humedad y temperatura. Pulverizar directamente sobre el cabello y peinar según el estilo deseado.

Gravity Zero: thanks to its composition, it leaves an invisible dry film on your hair providing it with outstanding volume and hydration. It is ideal for any type of hair, giving it an added touch of luminosity. Powerful even in damp and warm environments. Spray directly onto the hair and style as desired.



Laca profesional fuerte

Strong professional lacquer

u.m.vta: 1  12 

300 ml

REF.07129

Proporciona a tu cabello una excelente fijación y un brillo natural a la vez que lo protege de agentes externos como viento, humedad, etc.

Mantiene el peinado perfecto durante todo el día. Efecto Long lasting. Se elimina fácilmente con un ligero cepillado. Fortalece la fibra capilar.

It offers an excellent hold and a natural shine while protecting from external agents, like wind, dampness, etc.

It keeps the hairstyle perfect during the entire day. Long-lasting effect. Easily removed with a light brushing. Strengthens the hair fibres.



Laca ecológica

Ecologic hair spray

u.m.vta: 1  24 

300 ml

REF.07113

Captain Cook Hair Spray es ideal para trabajos estructurados, respeta el cabello gracias a la acción de la provitamina B5. Su difusión micro-fina no sobrecarga el cabello eliminándose fácilmente al cepillar.

Captain Cook Hair Spray is ideal for structured work. It respects the hair thanks to its pro-vitamin B5 content. Its micro-fine diffusion does not overload the hair, and it is easily removed by brushing.



Curls rock crema definicion de rizos

Curl definition cream curls rock

u.m.vta: 1  24 

250 ml

REF.07378

Crema que define y amplifica los rizos dando un aspecto natural. Enrichida con Proteínas de Trigo.

La crema definición de rizos está especialmente formulada para diseñar rizos y ondas en el cabello de forma fácil y cómoda. Las proteínas de trigo aportan hidratación y brillo, evitando el encrespamiento. Forma a tu look con los dedos. Dejar secar al aire o con difusor para una óptima definición del rizo.

Beneficios

- Definición de rizos
- Máxima Hidratación
- Volumen

It is a cream that defines and amplifies the curls, giving them a natural look. Enriched with wheat protein.

The curl definition cream is specially formulated to design curls and waves in the hair easily and comfortably. Wheat proteins provide hydration and shine, preventing frizz. Shape your look with your fingers. Allow to air or diffuse dry for optimal curl definition.



Benefits

- Defines curls
- Maximum moisturising action
- Provides volume



Polvo voluminizador Gravity Powder

Gravity Powder volumizer dust



u.m.vta: 1  15 

10 g

- Con pulverizador
- With sprayer

REF. 06473

Premio mejor
producto del año
Best prize product
of the year

u.m.vta: 1  20 

20 g

REF. 04962



Gravity Powder: polvo matificador texturizante ultra ligero. Aporta gran volumen al cabello, con su fácil aplicación masajeando mínimamente la raíz del pelo. Ideal para fijar peinados muy estructurados. Suave efecto mate. Gracias a sus activos, no deja el cabello grasiento, incluso en cabellos propensos, ayudando a absorber el exceso de seborrea. Control fuera. Fijación duradera.

Gravity Powder: ultra light texturing matifying powder. Provides great volume to the hair, with its easy application minimally massaging the hair root. Ideal for fixing very structured hairstyles. Soft matte effect. Thanks to its assets, it does not leave greasy hair, even in prone hair, helping to absorb excess seborrhea. With no control. Durable fixation.

Champú Bourbon 1874

Bourbon 1874 shampoo

u.m.vta: 1  2

5 L

REF. 07096

Champú especialmente formulado para hombres duros que quieren mantener su cabello limpio, brillante y resistente. Específico para todo tipo de cabellos y cuero cabelludo. Indicado para uso diario o frecuente. Protege el cabello y el cuero cabelludo dándole equilibrio y salud

Shampoo specially formulated for hard men who want to keep their hair clean, bright and resistant. Specific for all types of hair and scalp. Indicated for daily or frequent use. Protects hair and scalp giving balance and health.



Pack Barba

Beard pack

u.m.vta: 1  4

REF. 06668

Incluye champú para barba de 250 ml + aceite para barba 30 ml + cera para barba de 50 ml

Includes beard shampoo 250 ml + beard oil for 30 ml + beard wax 50 ml



Pack cabello

Hair pack

u.m.vta: 1  4

REF. 06669

Incluye champú refrescante de 250 ml + Gravity Powder de 20 g + cera mate de 50 ml

Includes refreshing shampoo 250 ml + Gravity Powder 20 g + matte wax 50 ml

u.m.vta: 1  10



REF. 07079

Necesar vacío
Empty bag



Aceite pre-afeitado

Pre-shave oil

u.m.vta: 1  6 

30 ml

REF. 04860





Para una agradable experiencia de afeitado. Producto especialmente diseñado para tratar la piel antes del afeitado. Contiene activos refrescantes que ayudan a deslizar la cuchilla de forma segura.

For a pleasant shaving experience. This product has been specially designed to treat your skin prior to shaving. It contains refreshing active ingredients that help the razor to glide safely.

Aceite para barba

Beard oil

u.m.vta: 1  6 

30 ml

REF. 04861





Barba sana y manejable. Mezcla de aceites naturales que nutren e hidratan el pelo de la barba ayudando a mantenerla sana y manejable. No graso.

For a healthy and manageable beard. This blend of natural oils nourishes and hydrates the hairs of your beard, contributing to keep it healthy and manageable. Does not leave an oily residue.

Cera para barba

Beard wax

u.m.vta: 1  6 

50 ml

REF. 04865





Domina tu barba. Alta concentración de activos naturales como el aceite de argán y rosa mosqueta, que protegen y nutren el pelo en profundidad sin dar ninguna sensación de grasa.

Tame your beard. This beard wax is rich in natural active ingredients such as argan oil and musk rose oil, which protect your beard's hairs in depth without giving it an oily or greasy feel.

Champú para barba

Beard shampoo

u.m.vta: 1  6 

250 ml

PH 5.5

REF. 04862





Limpieza profunda. Jabón de limpieza con propiedades hidratantes y suavizantes. Produce una espuma densa que arrastra las impurezas.

In-depth cleansing. Cleaning soap with hydrating and conditioning properties. It produces a dense foam that removes any impurities.

Crema de afeitado

Shaving cream

u.m.vta: 1  6 

250 ml

PH 5.5

REF. 04863





Afeitar es fácil... Formulada con activos suaves e hidratantes para la protección de la piel. Especialmente diseñado para abrir los poros, hidratar la piel y ablandar la barba para facilitar el afeitado.

Shaving has never been easier. The formula for this cream contains mild and hydrating active ingredients to protect your skin. It is especially designed to open your pores, hydrate your skin and soften your beard, making shaving a breeze.

Crema post-afeitado

Aftershave cream

u.m.vta: 1  6 

250 ml

PH 5.5

REF. 04864



Ideal para pieles sensibles. Sus componentes regenerativos y calmantes lo hacen ideal para después del afeitado, produciendo una agradable sensación de frescor e hidratación.

Ideal for sensitive skins. Its regenerating and soothing components make it ideal to apply after shaving, as it produces a pleasant sensation of freshness and hydration.

Expositor de pomadas Captain Cook Captain Cook hair pomades display

u.m.vta: 1  1

REF.06441

- 6 pomadas de cada ref. (50 ml y 100 ml)
- REGALO: expositor madera, 2 posters, 25 catálogos, 1 bolsa, 1 gorra
- 6 hold hair pomades of each reference (50 ml and 100 ml)
- GIFT: wooden display, 2 posters, 25 catalogs, 1 bag, 1 cap



REF.06441/01

Expositor vacío
Empty display



Expositor grande Captain Cook para barba y cabello Captain Cook big display beard + hair

u.m.vta: 1  1

REF.04944

- 2 unidades de cada referencia
- REGALO: expositor madera, 8 camisetas, 2 gorras, 2 bolsas, 50 catálogos y 5 posters
- 2 units of each reference
- GIFT: wooden display, 8 t-shirts, 2 caps, 2 bags, 50 catalogs and 5 posters

u.m.vta: 1  1

REF.04944/01



Expositor vacío
Empty display

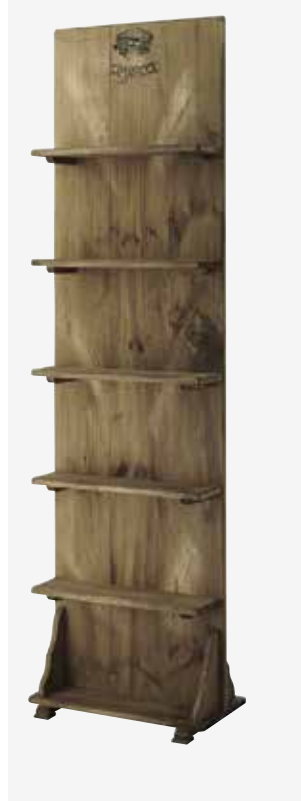



THE SHAVING CO. es un concepto 100% mexicano de estilo de vida que define al hombre moderno, con una colección de productos de cuidado personal masculino hechos a mano, desarrollados con la mejor tecnología e ingredientes de la más alta calidad que impulsan nuestros productos a nivel mundial. Desde 2014, THE SHAVING CO. combina la perfecta experiencia de nuestras exclusivas barberías con la creatividad de nuestros artistas y diseñadores, siempre a la vanguardia con productos y tratamientos para el cuidado del cabello del hombre.

SHAVING CO. es una experiencia única e inevitable que armoniza "masculinidad" con "estilo de vida", desde el diseño del grooming óptimo, basados en bienestar y el cuidado del medio ambiente.

Nuestra colección de 25 productos se presenta en cuatro series especializadas:

HAIR SERIES STYLING MASTERPIECES
NOXIDIL R SERIES
BEARD SERIES
SHAVING SERIES

THE SHAVING CO. is a 100% Mexican lifestyle concept that defines modern man, with a collection of handmade male personal care products, developed with the best technology and ingredients of the highest quality that drive our products worldwide. Since 2014, THE SHAVING CO. combines the perfect experience of our exclusive barbershops with the creativity of our artists and designers, always at the forefront with products and treatments for the hair care of man.

SHAVING CO. it is a unique and inevitable experience that harmonizes "masculinity" with "lifestyle", from the design of optimal grooming, based on well-being and care of the environment.

Our collection of 25 products is presented in four specialized series:

HAIR SERIES STYLING MASTERPIECES
NOXIDIL R SERIES
BEARD SERIES
SHAVING SERIES



After shaves Splash Splash after shaves

u.m.vta: 1  5

The Shaving Co. AFTER SHAVES es una serie de lociones para después de afeitarse hipo-alérgicas, dermatológicamente probadas y sin alcohol en envases pequeños cuidadosamente mezclados para un resultado superior en el cuidado de la piel y el afeitado del hombre. Ingredientes Premium 100% naturales que deleitan con notas puras y refrescantes en cada uno de sus aromas.

Beneficios:

- Proporciona una hidratación y nutrición superior para la piel y folículos pilosos sin agentes químicos
- Reduce la sensación de picazón y resequeza en la piel
- Reduce considerablemente la irritación y el enrojecimiento en la piel
- No contiene alcohol
- Producto hipoalérgico
- Disminuye la aparición de acné

The Shaving Co. AFTER SHAVES is a series of hypoallergenic, dermatologically tested and non-alcoholic after-shave lotions in carefully mixed small packages for superior skin care and shaving of the man. Premium ingredients 100% natural and delight with pure and refreshing notes in each of its aromas.

Benefits:

- Provides superior hydration and nutrition for skin and hair follicles without chemical agents
- It significantly reduces the sensation of itching and dry skin
- It considerably reduces the irritation and redness in the skin
- Does not contain alcohol
- Hypoallegenic product
- Decreases the appearance of acne

- Sándalo
- Sandalwood

100 ml

REF.06376



- Cítrico
- Citrus

100 ml

REF.06377



- Lavanda
- Lavender

100 ml

REF.06378



- 1888
- 1888



100 ml

REF.06379



Bálsamo para barba

Beard balm

u.m.vta: 1  24 

60 ml

Citrus

REF. 04488



Wilderness

REF. 04490



Woodland

REF. 04489



Bálsamo barba Mr. Bear Family es perfecto para el uso diario. La hidrata volviéndola más exuberante, suave y gustosa al tacto. Formulada sólo con productos naturales. Es una cera dura y debe ser calentada antes de la aplicación, mediante el almacenamiento en el bolsillo, frotando con los dedos o con un toque con el secador de pelo.

This Mr. Bear Family beard lotion is perfect for daily use, hydrating it and providing it with a lush, soft and pleasant look and feel. Made exclusively from natural products. This is a hard wax that must be heated before being applied, either by keeping it in your pocket, rubbing it with your fingers or by lightly warming it with a hair dryer.

Bálsamo para bigote

Moustache balm

u.m.vta: 1  24 

REF. 04493



Wilderness

30 ml



Aceite para barba

Beard oil

u.m.vta: 1  24 

30 ml

Woodland

REF. 04486



Wilderness

REF. 04487



Aceite para barba Mr. Bear Family elaborado solamente con aceites naturales. Suaviza y deja la barba manejable nutriendo además la piel. Ayuda a evitar el enrojecimiento y la irritación. Hidrata la barba dejándola suave, exuberante y fácil de peinar.

This Mr. Bear Family beard lotion is made exclusively from natural products. It softens the beard, making it easier to comb, and it also nourishes the skin. It helps prevent rashes and irritation. It hydrates the beard, making it soft, lush and easy to comb.

u.m.vta: 1  24 

REF. 04492

Citrus

30 ml



Bálsamo para bigote Mr. Bear Family para embellecer y dar forma al bigote. Cera dura que fija bien y deja el bigote en la forma deseada. La cera está hecha a mano, utilizando solo ingredientes naturales. Con manteca de karité, cera de abeja y aceites esenciales.

Mr. Bear Family moustache wax is meant to embellish and provide shape to your moustache. This is a hard wax that is effective at fixing your moustache and providing it with the desired shape. This wax is handmade exclusively from natural ingredients. Contains shea butter, beeswax and essential oils.



Aceite de afeitado Shaving oil



u.m.vta: 1

24



30 ml

REF. 04495

Aceite de afeitado Mr. Bear Family para una agradable experiencia de afeitado. Hecho a partir de aceites naturales. Gracias a su alta densidad la piel no lo absorbe. Ablanda la barba, por lo que es más fácil afeitar, y actúa como un escudo protector para la piel durante y después del afeitado. Todo ello hace que la cuchilla se deslice más suavemente sobre la piel. También ayuda a aliviar el enrojecimiento, irritación, picor y sequedad de la piel después del afeitado.

Mr. Bear Family shaving oil intended for a pleasant shaving experience. Made from natural oils. Its high density prevents it from being absorbed by the skin. It softens the beard, making shaving an easier task, and it acts as a protective shield for your skin during and after shaving. It also helps alleviate rashes, irritation, itchiness and skin dryness after shaving.



Bálsamo labial Lip balm

u.m.vta: 1

48



15 ml

Pink grape
REF. 04496



15 ml

Coco
REF. 04498



15 ml

Mint
REF. 04497



Labios suaves y protegidos. 100% natural y hecho a mano. Con agradables aromas a uva rosa, menta y coco. Nutre, protege y suaviza los labios desde la primera aplicación. Con aceite de coco, jojoba, manteca de karité, cera de carnauba y aceites esenciales.

Keeps your lips soft and protected. 100% natural and handmade. Available in pleasant grape, rose, mint and coconut scents. Nourishes, protects and softens the lips from the first time it is applied. Contains coconut oil, jujube oil and shea butter, as well as carnauba wax and essential oils.



Piedra de alumbre 100% natural 100% natural hand-cut alum stone

u.m.vta: 1  378

75 g

REF.04220



Cortada a mano, para calmar la piel y la irritación después del afeitado.

Hand cut, to calm skin irritation after shaving.

Jabón de afeitar con alumbre Shaving soap with alum

u.m.vta: 1  24

100 g

REF.04219



Jabón de afeitar con alumbre. Su fórmula única 100% a base de piedra de alumbre y manteca de karité prepara la zona para el paso de la navaja y hace el afeitado un ritual muy agradable.

Shaving soap with alum. Its unique 100% alum stone and shea butter formula prepares the area for contact with the razor blade, making shaving a supremely pleasant ritual.

Lápiz hemostático Haemostatic pencil

u.m.vta: 12  1440

12 g

REF.04218



Granel

Bulk

REF.04218/01

Lápiz hemostático para tratamiento de micro cortes en el afeitado. Fabricado con alumbre de potasio. Certificado CE. Uso externo y personal. Viene en un práctico y seguro tubo de viaje para facilitar su uso.

Haemostatic pencil intended to treat micro-cuts caused during shaving. Made from potassium alum. CE Certified. External and personal use. Presented in a convenient and safe travel tube for easy use.

Kit afeitado Shaving kit

u.m.vta: 1  1

REF.04221



Compuesto por:

- Cofre de madera
- Lápiz hemostático 12 gr
- Jabón de afeitar con alumbre 100 gr
- Piedra de alumbre 75 gr
- Brocha de madera

Made up of:

- A wooden box
- A 12 gr haemostatic pencil
- 100 gr alum shaving soap
- 75 gr alum stone
- Wooden shaving brush

MYRSOL



Masaje agua de limón regeneradora de la capa natural de la piel

Limon after shave regenerating the natural layers of the skin

u.m.vta: 1  8

180 ml

REF.03866

Regenerador de la capa natural ácida de la epidermis del cutis y de la piel. En general, el ácido del limón es eficaz contra granitos y la seborrea facial y suaviza la piel. Para afeitarse a diario sin dolor y calmar instantáneamente el escozor del afeitado. Tónico astringente. Produce una extraordinaria sensación de frescor, y posee un agradable aroma. Recomendada para pieles grasas. Solución hidroalcohólica.

Regenerator of the natural acid layer of the skin and skin epidermis. In general, the lemon acid is effective against spots and the facial seborrhea and made the skin softer. To shave daily without pain and instantly calm the scrub of the shaved. Astringent tonic. It produces an extraordinary sensation of fresh, and has a pleasant aroma. Recommended for oily skin. Hydro-alcohol solution.

200 ml

REF.04352



Masaje Antesol para antes y después del afeitado

Antesol after shave to apply before and after shaving

u.m.vta: 1  8

200 ml

REF.04650

Masaje Antesol Myrsol para antes y después del afeitado. Favorece la regeneración de las células de la piel dañada, y reduce la sensación de dolor. Indicado para tratar pieles secas como humectante. El resultado es una piel más tersa y sana. Recomendado para pieles secas. Solución hidroalcohólica.

Myrsol Antesol after shave for before and after shaving. Helps to the regeneration of damaged skin cells, and reduces the sensation of pain. Indicated to treat dry skins as a moisturizer the result is a more smooth and healthy skin. Recommended for dry skin. Hydro-alcohol solution.

180 ml

REF.03867

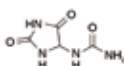
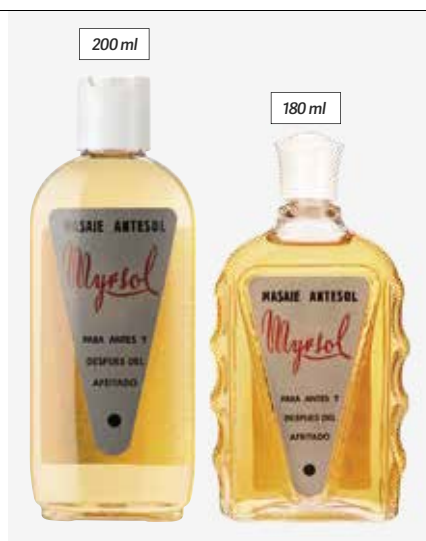
Alantoina
Allantoin

Myrsol

After shave Fórmula K tónico. Refrescante mentolado

Formula K tonic after shave. Refreshing, minty scent

u.m.vta: 1  8

200 ml

REF.04643

After shave Fórmula K. Su acción refrescante y tónica ayuda a calmar el dolor y la irritación. Por delicado que sea su cutis retiene la humedad y elasticidad natural, evitando el envejecimiento prematuro de la piel. Recomendado para pieles secas.
Solución hidroalcohólica

180 ml

REF.03872

Formula K after shave. Its refreshing and tonic action helps calm pain and irritation. Don't matter how delicate it is your cutis holds moisture and natural elasticity, avoiding aging premature skin. Recommended for dry skin.
Hydro-alcohol solution



After shave agua balsámica regeneradora de la piel

Balsamic water after shave regenerating the skin

u.m.vta: 1  8

200 ml

REF.04642

Excelente regenerador de la piel. Calmante de la irritación del afeitado. Está elaborada con sustancias extraídas del romero, del espliego del tomillo y de otras plantas indicadas para descongestionar las partes afectadas por rozaduras, contusiones y para después del afeitado y depilado. Recomendado para pieles grasas.
Solución hidroalcohólica.

180 ml

REF.03875

Excellent regenerator of the skin. Smoother effect of shaving irritation. It is prepared with substances extracted from rosmery, from the structure of the thyme and other plants indicated to decongestate the parts affected by rashes, contusions and after shaving and shaving. Recommended for oily skin.
Hydro-alcohol solution



Emulsión para afeitado sin alcohol para el masaje antes y después del afeitado

Alcohol-free shaving emulsion intended for massage before and after shaving

u.m.vta: 1  8

200 ml

REF.04587

u.m.vta: 1  8

180 ml

REF.03869

u.m.vta: 1  16

75 ml

REF.04887

- Roll-on
- Roll-on



Indicaciones: para afeitarse sin dolor sin brocha ni jabón y para el masaje antes y después del afeitado. Para un afeitado perfecto para la barba más difícil y para el más delicado cutis. Un producto de efectos sorprendentes. Esta emulsión es sumamente hidratante, nutritiva, hemostática, analgésica. Indicado para patillas y contorno de barbas. Recomendada para pieles sensibles. Solución no alcohólica.

Indications: to shave without pain without brush or soap and for the massage before and after the shave. For a perfect shave for the most difficult beard and the most delicate skin. A product of amazing effects. This emulsion is extremely hydrating, nutritive, hemostatic, analgesic. Indicated for sideburns and contour of beards. Recommended for sensitive skin. Non-alcohol solution.

Masaje F./ Extra F./Extra after shave

u.m.vta: 1  8

180 ml

After shave

REF.03877



Loción calmante de cualquier clase de irritación producida por el afeitado. Aporta a la piel tersura, tonicidad y una agradable sensación de frescor, con efecto cicatrizante y balsámico.

It has a calming effect on any irritation produced during shaving. Makes the skin soft and tone and provides it with a pleasant feeling of freshness, with a healing and balsamic effect.

Masaje Metilsol Metilsol after shave

u.m.vta: 1  8

180 ml

REF.03878



Tiene propiedades cicatrizantes y astringentes y equilibra la función de las glándulas sebáceas evitando la aparición de granitos en la piel. Ayuda a prevenir irritaciones e infecciones de la piel. Hemoestática eficaz contra los microcortes del afeitado.

This lotion has healing and astringent properties, and it balances the functioning of the sebaceous glands, preventing the appearance of zits on your skin. It helps prevent rashes and infections on the skin. It also has a clotting effect on micro-cuts produced during shaving.

Tónico facial Fórmula C Formula C facial tonic

u.m.vta: 1  8

180 ml

REF.03874



Indicado para el cuidado de la piel, especialmente pieles grasas. Regenera la epidermis, refresca y repara la piel después del afeitado. Hidratante, relajante y calmante recomendado para pieles grasas. Solución hidroalcohólica.

Especially recommended to care for oily skins. It regenerates the epidermis, refreshing and repairing the skin after shaving, with a hydrating, relaxing and calming effect that is particularly suitable for oily skins. This solution is based on water and alcohol.

Masaje facial Plastic Shave Plastic Shave facial massage

u.m.vta: 1  8

180 ml

REF.03871



Para lograr afeitarse a diario sin dolor ni molestias. Muy apropiado también para neutralizar picaduras de mosquitos y otros dípteros. Mejora la textura y el tono de la piel y el aspecto en general, recomendado para pieles sensibles. Solución hidroalcohólica.

For a pain and hassle-free daily shave. It is also very suitable to treat mosquito and other insect bites. It improves the tone and texture from the skin as well as its general look, and it is very suitable for sensitive skins. This solution is based on water and alcohol.

Masaje Electric Electric after shave

u.m.vta: 1  8

180 ml

REF.03868



Loción indicada para lubricar la piel y la máquina eléctrica antes del afeitado. Permite el deslizamiento de la máquina para reducir la fricción y la irritación de la piel. Solución alcohólica.

This lotion is suitable to lubricate the skin as well as your electric shaver before shaving. It allows the shaver to slide easily, thus reducing friction and skin irritation. This solution is based on water and alcohol.

Masaje Blue Blue after shave

u.m.vta: 1  8

180 ml

REF.03873



Myrsol-After shave Blue. El complemento perfecto para después del afeitado por sus propiedades tónicas y calmantes. Excelente para afecciones de la piel: inflamación, irritación, deshidratación. Aporta frescura, tonicidad, vitalidad. Posee una fragancia distinguida perdurable al contacto con la piel, y es recomendado para pieles secas. Solución hidroalcohólica.

Myrsol Blue After shave. This is the perfect addition after your daily shave owing to its toning and calming properties. It is particularly suitable to combat skin problems such as inflammation, irritation or dehydration. It provides freshness, tone and vitality to the skin. It has a distinctive and long-lasting fragrance in contact with the skin, and it is suitable for dry skins. This solution is based on water and alcohol.

Loción capilar vitalizante Vitalizing hair lotion

u.m.vta: 1  6

235 ml

REF.04644



- Regeneradora del cuero cabelludo, anticascpa y antiseborréica
- SIN ACLARADO

• This solution regenerates the scalp and it helps combat dandruff and oiliness

• DOES NOT REQUIRE RINSING

u.m.vta: 1  12

1000 ml

REF.06242

u.m.vta: 1  8

200 ml

REF.03876

- Jabón líquido para afeitado con brocha
- Liquid soap for brush shaving



Cerillas hemostáticas 20 servicios

Haemostatic matches 20 services

u.m.vta: 1  16

REF.06194

- Expositor 50 cajitas. 20 servicios cerillas hemostáticas
 - Fórmula 100% natural, fácil de usar, de transportar y antisépticas
 - Caja de presentación por unidades
 - 50 libritos por caja
 - 20 cerillas en cada librito
 - 300 gr
 - Fabricado en PRC
- Exhibitor 50 boxes. 20 haemostatic match services
 - 100% natural formula, easy-to-use, portable, antiseptic
 - Counter display box
 - 50 books per box
 - 20 matches each book
 - 300 gr
 - Produce in PRC



Pomada THE LEGENDS

Pomade THE LEGENDS

u.m.vta: 1  12

120 ml

REF.06195



Gel THE LEGENDS

Gel THE LEGENDS

u.m.vta: 1  12

220 ml

REF.06197



Fácil de aplicar, remodelar y eliminar, fijación fuerte

- Fuerte fijación - para todo el día
- Olor suave y limpio
- Consistencia ligera
- Color claro
- Brillo medio
- Apto para todo tipo de estilos
- Fácil de aplicar
- Tarro de plástico blanco
- Estilo vintage
- 4 oz / 120 ml
- Fabricado en la UE

Easy to apply, reshape and remove, strong hold

- Strong all-day hold
- Light and clean scent
- Light consistency
- Clear colour
- Medium shine
- All-type of styles
- Easy to apply
- White plastic jar
- Vintage style
- 4 oz / 120 ml
- Produce in EU

Producto "old school" de fijación fuerte, nutritivo, restyling.

- Fuerte fijación - todo el día
- Fragancia
- Consistencia suave
- Color rojo semitransparente
- Brillo medio sobre el cabello mojado
- Mate medio sobre cabello seco
- Todo tipo de estilos
- Tarro plástico blanco
- Estilo vintage
- 4 oz / 220 ml
- Producido en la UE

Old school product strong hold, nourishing, restyling

- Strong all-day hold
- Fragrance
- Soft consistency
- Semi-transparent red colour
- Medium shine on wet hair
- Medium matte on dry hair
- All type of styles
- White plastic jar
- Vintage style
- 4 oz / 220 ml
- Produced in EU

Champú prevención caída

Hair loss prevention shampoo

u.m.vta: 1  12

1000 ml

REF.03566

- Champú formulado específicamente para combatir la caída del cabello, ya que combina proteínas y bionutrientes de origen vegetal, que actúan como descongestivos y revitalizantes, evitando la irritación
- Limpia en profundidad, eliminando las grasas que se forman en el cuero cabelludo dejando así que el nuevo cabello se desarrolle sin impedimentos
- El cabello queda suave, brillante y sedoso

u.m.vta: 1  6

400 ml

REF.03555

- *This shampoo has been specifically designed to combat hair loss, as it combines vegetable proteins and bio-nutrients with a decongestive and revitalising effect that help prevent irritation*
- *Cleanses in depth, eliminating any fat that builds up on the scalp, allowing new hair to develop freely*
- *Makes hair soft, shiny and silky*



Ampollas prevención caída

Hair loss prevention vials

u.m.vta: 1  6

REF.03550

- 12 ampollas prevención caída
- Champú prevención 400 ml

- *12 hair loss prevention vials*
- *Hair loss prevention shampoo 400 ml*

u.m.vta: 1  6

REF.03551

- 12 ampollas prevención caída
- 10 ml cada vial

- *12 hair loss prevention vials*
- *10 ml each vial*





Los mejores nutrientes para el cuero cabelludo son las proteínas de origen vegetal. Potencian la absorción de éstos y favorecen la oxigenación del folículo piloso, disminuyendo así la caída del cabello. Los nutrientes vegetales también actúan como descongestivos y revitalizantes, evitando la irritación. La queratina repara y fortalece el cabello, dándole volumen y brillo.

The best nutrients for the scalp are proteins of vegetable origin. They promote the absorption of nutrients and help oxygenate hair follicles, thus reducing hair loss. Vegetable nutrients also have a decongestive and revitalising effect that helps prevent irritation. Keratin repairs and strengthens hair, providing it with volume and shine.

Fibras capilares

Hair fibers

 u.m.vta: 1  6 

- Con dosificador
- Para hombre y mujer. Ideal para la pérdida de densidad capilar. Disimula las zonas de poco pelo de forma rápida y natural
- Se adhiere al cabello dándole mayor volumen y grosor
- Se aplica fácilmente, agitando el tarro encima de la zona de aplicación
- Disponible en 6 colores: negro, castaño oscuro, castaño medio, castaño claro, rubio oscuro y gris claro que se adaptan a la tonalidad del color natural del pelo

- With dispenser
- For men and women. Ideal for the loss of hair density. It quickly and naturally conceals areas with little hair
- It adheres to the hair giving it more volume and thickness
- It is easily applied by shaking the jar over the application area
- Available in 6 colours: black, dark brown, medium brown, light brown, dark blonde and light grey that adapt to the tone of the natural colour of the hair

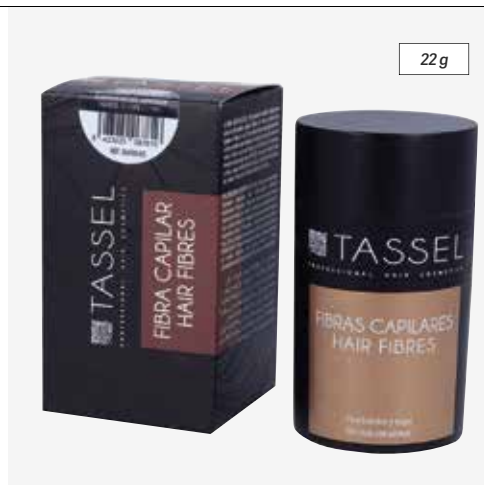

Negro · Black
REF.06436/50

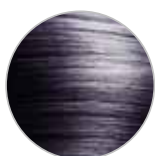

Gris claro · Light grey
REF.06436/72

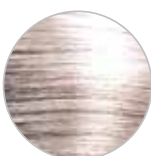

Rubio oscuro · Dark blonde
REF.06436/66

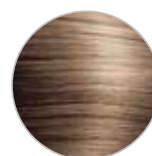

Castaño oscuro · Dark brown
REF.06436/67



Castaño medio · Medium brown
REF.06436/76

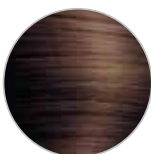



Castaño claro · Light brown
REF.06436/65



Atomizador de fibras capilares

Hair Fiber Atomizer

 u.m.vta: 1  12 

REF.07208



- Fácil de usar
- Permite una distribución más uniforme de las fibras capilares en áreas específicas.
- Permite que las fibras se adhieran a tu cabello natural mucho más fácilmente. Se necesita menos cantidad de producto para lograr el look deseado.
- Fácil de almacenar

CÓMO UTILIZAR:

Vierta las fibras del cabello en la botella de vidrio y coloque el atomizador para pulverizarlas. Presione la bomba hacia arriba y abajo para este propósito.

- Easy to Use
- Allows a more even distribution of hair fibers into specific areas.
- It allows the fibers to attach to your natural hair much easier. Less amount of product is needed to achieve desired look.
- Easy to store

HOW TO USE:

Pour the hair fibers into the glass bottle and install the atomizer to spray them. Press the pump up and down for this purpose.

Laca fibras capilares

Hair fibers spray

u.m.vta: 1  30 

100 ml

REF.06649

Para máxima fijación y sujeción de las fibras

For maximum fixation and fastening of the fibers



Expositor fibras capilares (de regalo)

Hair fibres exhibitor (as a gift)

u.m.vta: 1  1

REF.07801

Incluye 6 tonos fibras capilares + laca fijación

- Ref. 06436/50 Negro 22g.
- Ref. 06436/72 Gris claro 22g.
- Ref. 06436/66 Rubio oscuro 22g.
- Ref. 06436/67 Castaño oscuro 22g.
- Ref. 06436/76 Castaño medio 22g.
- Ref. 06436/65 Castaño claro 22g.
- Ref. 06649 Laca fijación fibras capilares 100 ml.

Includes 6 shades of hair fibres + fixing lacquer

- Ref. 06436/50 Black 22g
- Ref. 06436/72 Light grey 22g
- Ref. 06436/66 Dark blonde 22g
- Ref. 06436/67 Dark chestnut 22g
- Ref. 06436/76 Medium chestnut 22g
- Ref. 06436/65 Light chestnut 22g
- Ref. 06649 Hair fibre fixing lacquer 100 ml
- Sum: 1 unit per box 1



Roll-on cera hombre

wax roll-on for man

u.m.vta: 24  24

100 ml

REF.03858

El sistema de depilación roll-on es óptimo para aquellos profesionales que buscan conseguir los mejores resultados. Las resinas con las que fabricamos las ceras pueden utilizarse a mayor temperatura que la cera de baja fusión, con la ventaja que se aplican mediante una tira más fina. Así, la cera se enfría casi al instante y la sensación de calor en la piel se minimiza. La cera se retira fácilmente con las bandas higiénicas. Precios escaladas combinables página 556-557-558

The roll-on hair removal system is optimal for those professionals who want to achieve the best results. The resins with which we make the waxes can be used at a higher temperature than the low melting wax, with the advantage that they are applied with a thinner strip. The wax cools almost instantly and the sensation of heat in the skin is minimized. Wax is easily removed with hair removal bands. Combinable scaled prices page 556-557-558



07

Mobiliario y decoración Furniture & decoration

*Polo barbero, sillones barbero, lavacabezas,
sillas niño, espejos y carritos...*

*Barber pole, barber armchair, wash basin chair,
children's seats, mirrors and trolleys...*



Polo barbero
Barber pole

Con cable
With cable

u.m.vta: 1	 1	 1
------------	---	---

REF. 04745

- | | |
|--|--|
| <ul style="list-style-type: none"> • Potencia: 12W • Velocidad giro: 50-60 RPM • Polo barbero farolillo vintage • Opción de luz y giro • Voltaje: 220-240V~ • Frecuencia: 50/60 Hz | <ul style="list-style-type: none"> • Power: 12W • 50-60 RPM • Black vintage barber pole • Optional rotating and light • Voltage: 220-240 V ~ • Frequency: 50/60 Hz |
|--|--|

REF. 04578

- | | |
|--|--|
| <ul style="list-style-type: none"> • Potencia: 13W • Velocidad giro: 50-60 RPM • Polo barbero negro luminoso y rotativo Ø 20 cm • Opción de luz y giro • Voltaje: 220-240V~ • Frecuencia: 50/60 Hz | <ul style="list-style-type: none"> • Power: 13W • 50-60 RPM • Black luminous and rotary barber pole Ø 20 cm • Optional rotating and light • Voltage: 220-240 V ~ • Frequency: 50/60 Hz |
|--|--|

REF. 04744

- | | |
|--|--|
| <ul style="list-style-type: none"> • Potencia: 13W • Velocidad giro: 50-60 RPM • Polo barbero cromado con esfera luminosa • Opción de luz y giro • Voltaje: 220-240V~ • Frecuencia: 50/60 Hz | <ul style="list-style-type: none"> • Power: 13W • Spin speed : 50-60 RPM • Chromed barber pole with luminous sphere • Optional rotating and light • Voltage: 220-240 V ~ • Frequency: 50/60 Hz |
|--|--|

REF. 04743

- | | |
|--|---|
| <ul style="list-style-type: none"> • Potencia: 13W • Velocidad giro: 30 RPM • Polo barbero cromado grande • Opción de luz y giro • Voltaje: 220-240V~ • Frecuencia: 50/60 Hz | <ul style="list-style-type: none"> • Power: 13W • Spin speed: 50-60 RPM • Large chromed pole • Optional rotating and light • Voltage: 220-240 V ~ • Frequency: 50/60 Hz |
|--|---|

REF. 04946

- | | |
|--|--|
| <ul style="list-style-type: none"> • Potencia: 17W • Velocidad giro: 50-60 RPM • Polo barbero cromado pequeño • Opción de luz y giro • Voltaje: 220-240V~ • Frecuencia: 50/60 Hz | <ul style="list-style-type: none"> • Power: 17W • Spin speed: 50-60 RPM • Small chromed barber pole • Optional rotating and light • Voltage: 220-240 V ~ • Frequency: 50/60 Hz |
|--|--|



El origen del poste de barbero rojiblanco, se remonta a la época medieval donde los barberos efectuaban operaciones de cirugía a sus clientes, así como extracciones de dientes. El poste originalmente tenía una palangana de bronce en la parte superior, representando el recipiente donde guardaban las sanguijuelas, y otro en la parte inferior, en alusión al recipiente que recibía la sangre. El propio poste simboliza el palo o bastón que el paciente agarraba durante el procedimiento para facilitar que la sangre fluyese. Es por ello, que el poste de barbero se asocia a los servicios ofrecidos, entre ellos las sangrías. Históricamente se representaba con vendajes sangrientos enrollados alrededor de un poste.

The origin of the white and red barber's post dates back to the medieval era where barbers performed surgery on their clients, as well as tooth extractions. The post originally had a bronze basin at the top, representing the container where the leeches were stored, and another at the bottom, alluding to the recipient receiving the blood. The pole itself symbolizes the stick or stick that the patient grabbed during the procedure to facilitate blood flow. That is why the barber pole is associated with the services offered, among them the sangria. Historically it was depicted with bloody bandages wrapped around a pole.

Sillón barbero **SPRINGFIELD**

SPRINGFIELD barber armchair

u.m.vta: 1  1

REF.06955



SCAN ME!

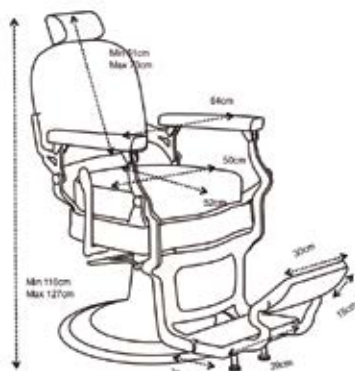

El nuevo sillón de barbero Springfield está diseñado con un estilo moderno pero sin perder su funcionalidad y sus líneas clásicas. El sillón tiene una bomba hidráulica la cual nos permite subir y bajar el asiento, de esta forma podremos situar a nuestro cliente a la altura que mejor se adapte a nuestro trabajo. La espuma del respaldo tiene un grosor de 6 cm y del asiento de 11 cm, esto hará que nuestro cliente se adapte bien al sillón y se encuentre muy cómodo. El reposacabezas es extraíble y ajustable por lo tanto lo podemos adaptar a cada trabajo. El respaldo del sillón puede ser inclinado 108 grados, al mismo tiempo que inclinamos el respaldo, la estructura del apoyapiés también se inclinará para dar el máximo confort.

The new Springfield barber armchair is designed in a modern style but without losing its functionality and classic lines. The chair has a hydraulic pump which allows us to raise and lower the seat, so we can place our client at the height that best suits our work. The foam of the backrest has a thickness of 6 cm and the seat of 11 cm this will make our client adapts well to the armchair and is very comfortable. The headrest is removable and adjustable so we can adapt it to each job. The backrest of the chair can be tilted 108 degrees, while we lean the backrest, the footrest structure will also be tilted to give maximum comfort.

Sillón barbero **STAFFORD**

STAFFORD barber armchair

u.m.vta: 1  1 

REF.06956/50

REF.06956/50



SCAN ME!



El nuevo sillón de barbero Stafford está diseñado con líneas y acabados retro. Se considera un sillón "vintage" ya que mezcla acero y tela con un efecto desgastado. Con calidad de última generación, está dotado de una bomba hidráulica para regular la altura del asiento. El apoyapiés es giratorio y el respaldo es reclinable. El reposacabezas es extraíble y también ajustable para así, adaptarlo a cada trabajo. Disponible en colores negro y marrón. Inclinación de 120 grados aproximadamente.

The new Stafford barber armchair is designed with retro lines and finishes. It is considered a "vintage" armchair since it mixes steel and fabric with a worn effect. With the latest generation quality, it is equipped with a hydraulic pump to adjust the seat height. The footrest is swivel and the backrest is reclining. The headrest is removable and also adjustable to adapt it to each job. Available in black and brown colors. Tilt of approximately 120 degrees.

Sillón barbero VIGOR

VIGOR barber armchair

u.m.vta: 1  1

REF.04888



REF.04888/73

SCAN
ME!

El sillón de barbero VIGOR está diseñado con un estilo moderno pero sin perder su funcionalidad y sus líneas clásicas. El sillón tiene una bomba hidráulica, la cual permite subir y bajar el asiento, de esta forma se podrá situar a nuestro cliente a la altura que mejor se adapte al trabajo. La espuma del respaldo tiene un grosor de 13,5 cm y del asiento de 11,5 cm, esto hará que el cliente se adapte bien al sillón y se encuentre muy cómodo. El reposacabezas es extraíble y ajustable por lo tanto se puede adaptar a cada trabajo. El respaldo del sillón puede ser inclinado 130 grados, al mismo tiempo que se inclina el respaldo. La estructura del apoyapiés también se inclinará para dar el máximo confort.

The new VIGOR barber armchair has a modern style and keeps the same functionality and its classic line. The chair has a hydraulic pump that allows to lift and lower the seat, so we can place the client in the proper spot to work. The foam of the backrest thickness is 13,5 cm and the seat is 11,5 cm. This way, the client will fit well to the chair and will be very comfortable. The headrest is removable and adjustable so we can adapt it to each client. The backrest of the chair can be tilted 130 degrees. At the same time that the backrest can be tilted, the structure of the footrest will also tilt for maximum comfort.



Sillón barbero CLASSIC

CLASSIC barber armchair

u.m.vta: 1  1

●
REF.06087/50

●
REF.06087/73

●
REF.06087/62



SCAN
ME!

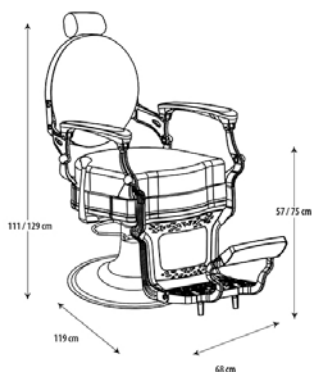

El sillón de barbero CLASSIC con líneas clásicas y acabados de última generación. Está dotado de bomba hidráulica para regular la altura del asiento. El apoyapiés es giratorio y el respaldo reclinable para dar el máximo confort al cliente. La espuma del respaldo tiene un grosor de 2,5 cm y del asiento de 7,5 cm, esto hará que el cliente se adapte bien al sillón y se sienta muy cómodo. También el reposacabezas es extraíble y ajustable para adaptarlo a cada trabajo. Disponible en tres colores: negro, granate y verde.

CLASSIC barber armchair with classic lines and last generation finishes. It has a hydraulic pump to regulate the height of the seat. The footrest is rotating and the backrest reclines to give maximum comfort to the customer. The foam of the backrest has a thickness of 2.5 cm and the seat of 7.5 cm, this will make the customer fit the chair better and feel very comfortable. The headrest is also removable and adjustable to adapt it to each job. Available in three colors: black, garnet and green.

Sillón barbero hidráulico MODERNIS

MODERNIS hidraulic barber armchair

u.m.vta: 1  1

REF. 03628

- Gira a 360°
- Anchura de brazo a brazo 57 cm
- Cabezal 19 x 13 cm
- Respaldo 51 x 41 cm
- Reclinable 130°

- Can swivel 360°
- Width from arm rest to arm rest 57 cm
- Head rest 19 x 13 cm
- Back rest 51 x 41 cm
- Reclines up to 130°



Sillón barbero hidráulico personalizado Customised hydraulic barber armchair

u.m.vta: 1  1

REF.04508/01



PERSONALIZA TU SILLÓN

1. DECIDE EL COLOR DE LA BASE
2. ELIGE EL COLOR DEL ASIENTO

- Estructura de la silla: aluminio fundido
- Las piezas cromadas son de bronce y hierro
- La estructura sobre la que va el tapizado es de pino
- Espuma y revestimientos certificados
- Base recubierta de poliéster pintado (mismo sistema que los coches)



CUSTOMIZE YOUR ARMCHAIR

1. CHOOSE A BASE COLOUR
2. CHOOSE A COLOUR FOR THE SEAT

- Chair structure: cast aluminium
- The chromed parts are made from bronze and steel
- The upholstery is laid upon a pine structure
- Certified foam and linings
- The base is covered in painted polyester (the method used in the car manufacturing industry)

Silla reclinable

Reclining chair

u.m.vta: 1  1 

REF. 02975/50

- Reclinable 130° / hidráulica
- Anchura de brazo a brazo: 57 cm
- Anchura cabezal de la silla: 19 cm
- Respaldo: 51 x 41 cm
- Altura cabezal: 13 cm
- Distancia entre respaldo y cabezal: 14 cm
- Peso: 32,5 kg
- Cabezal extraíble con una posición

- Reclining 130° / hydraulics
- Width from arm rest to arm rest: 57 cm
- Width of chair head: 19 cm
- Backrest: 51 x 41 cm
- Head height: 13 cm
- Distance between backrest and head: 14 cm
- Weight: 32,5 kg
- Removable head with one position



Sillón barbero TRADITIONAL

TRADITIONAL barber armchair

u.m.vta: 1  1

REF.06089/50



SCAN ME!

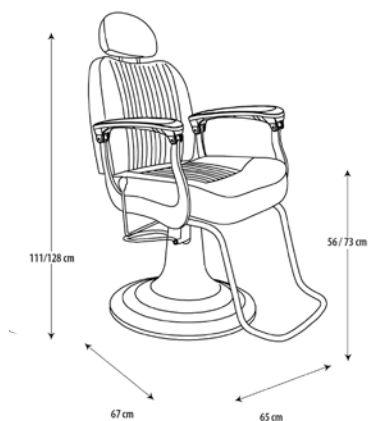

El sillón de barbero TRADITIONAL ha sido fabricado como un sillón sobrio y fácil de manejar, de estilo muy vintage, sin olvidar la comodidad. Está dotado de bomba hidráulica para regular la altura del asiento y de respaldo reclinable para dar el máximo confort al cliente. La espuma del respaldo tiene un grosor de 9 cm y del asiento de 10 cm, esto hará que el cliente se adapte bien al sillón y se sienta muy cómodo. El reposacabezas es extraíble y ajustable a diferentes alturas. También tiene un cómodo reposapiés.

The TRADITIONAL barber armchair has been manufactured as a sober and easy to handle, very vintage style chair, without forgetting the comfort. It is equipped with hydraulic pump to regulate the height of the seat and to recline back to give the maximum comfort to the client. The foam backrest has a thickness of 9 cm and the seat of 10cm this will make the client fit the armchair better and feel very comfortable. The headrest is removable and adjustable to different heights. It also has a comfortable footrest.

Lavacabezas TRADITIONAL

TRADITIONAL wash basin chair

u.m.vta: 1	 1
------------	---

REF.06090/50

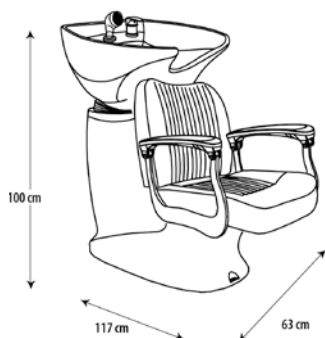

El lavacabezas TRADITIONAL siguiendo la línea del sillón barbero TRADITIONAL (ref.06089/50) ha sido fabricado como un lavacabezas sobrio y de estilo muy vintage, sin olvidar la comodidad. ¡Completa el diseño de tu salón con este lavacabezas!

The TRADITIONAL wash basin, following the line of the traditional barber armchair (ref.06089/50) has been manufactured as a sober and very vintage style wash basin, without forgetting the comfort. Complete the design of your salon with this wash basin!

Lavacabezas STAFFORD

STAFFORD wash basin chair

u.m.vta: 1	 1
------------	---

REF.06957/50

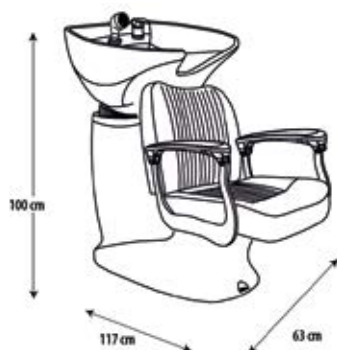

REF.06957/69



El lavacabezas Stafford, siguiendo la línea del sillón de barbero "traditional" (ref.06089/50) sigue también la estética del lavacabezas "traditional" pero con la diferencia que el lavacabezas Stafford se caracteriza por ser de acero y tener un acabado desgastado en el asiento "vintage"

The Stafford wash basin, following the line of the "traditional" barber chair (ref.06089/50) also follows the aesthetics of the "traditional" wash basin but with the difference that the Stafford wash basin is characterized by being made of steel and have a worn finish "vintage" on the seat.

Lavacabezas STIL
STIL wash basin chair

u.m.vta: 1  1 

* Recambios disponibles
 * Available spare parts

●
REF. 02841

●
REF. 02841/54

○
REF. 02841/58



- Apoyabrazos y mando cromados
- Teja de cerámica y base fibra de vidrio
- Asiento deslizable
- Largo base 76 cm
- Anchura asiento 48 cm
- Alto respaldo 41 cm
- Cerámica 57 x 50 x 20 cm
- Altura total 95 cm

- Chromed arm rests and controller
- Ceramic tile and fibreglass base
- Sliding seat
- Base length 76 cm
- Seat width 48 cm
- Back rest height 41 cm
- Ceramic tile 57 x 50 x 20 cm
- Total height 95 cm

Sillas para niños

Children's seats

u.m.vta: 1  1

Sillas para niños de gran calidad, fabricadas en metal y con un estilo vintage para que la experiencia de ir a la peluquería sea agradable para los niños. Coches a pedales que funcionan si se desmontan del soporte. Luces decorativas y cinturón de seguridad. Además, si se gira el volante, se mueven las ruedas delanteras. No contiene claxon.

High-quality children seats made from metal in a vintage style to make the trip to the hairdressing's a pleasant and drama-free experience. Pedal cars that function when detached from their base. Decorative lights and seat belt. Moreover, if you turn the steering wheel, the front wheels move. Do not have horn.



24 kg



REF.04728



26,8 kg



REF.04727



Silla especial para niños Special children's seats

u.m.vta: 1  1

REF.02733



Cojines especiales para niños Special cushions for kids

u.m.vta: 1  2

REF.07329/50



Cojines especiales para niños Special cushions for kids

u.m.vta: 1  1

REF.03939

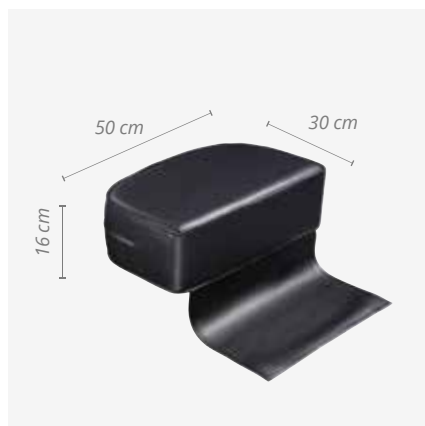

Cojines especiales para niños Special cushions for kids

u.m.vta: 1  1

 REF.04506/50  REF.04506/60

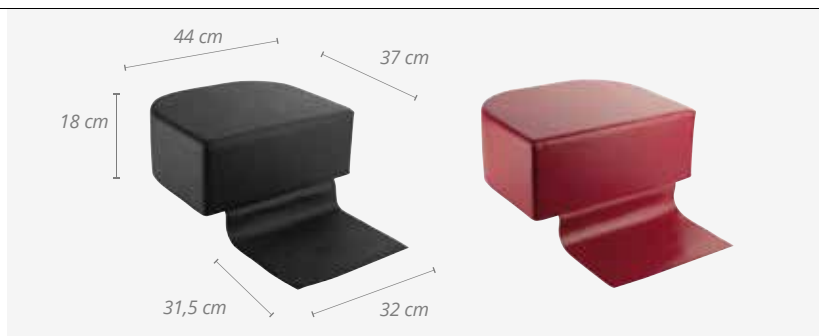

Cojines especiales aptos para cualquier sillón de peluquería. Permiten un trabajo más cómodo al profesional, ya que elevan al niño a la altura idónea.

Special cushions that are suitable for all kinds of hairdressing's seats, allowing professionals to work more comfortably by placing children to the ideal height.

Espejo de pared BARBER

BARBER wall mirror

u.m.vta: 1  1

REF.06091

El espejo de pared BARBER, de estilo vintage, es funcional y práctico gracias a su estantería ya que permite a apoyar los objetos que se deseen. ¡Aporta un toque "Old school" a tu salón!

The BARBER wall mirror, vintage style, is functional and practical for its shelf to rest the objects you want. Give an "old school" touch to your salon!



Tocador rústico Barber Line

Barber Line dressing table

u.m.vta: 1  1

REF.06670

Tocador fabricado en resina de poliuretano con base en mdf, material con mejores propiedades que la madera en cuanto a su resistencia y estabilidad. Calificación ignífuga, autoextinguible y antibacteriano. Acabado en madera rústica con dos piezas ornamentales imitando el hierro de color negro. Tacto similar madera, imitación perfecta.

Dressing table made of polyurethane resin on MDF, a material with better properties than wood in terms of resistance and stability and with self-extinguishing fireproof and antibacterial grading. Rustic wood finish with two ornamental pieces that imitate iron in black. It has a wood-like feel, in perfect imitation.



Carrito barbero madera y metal TOD
TOD wood and metal barber trolley

u.m.vta: 1  1



REF.04698/54



Bidón Captain Cook
Captain Cook can

u.m.vta: 1  1

REF.06054



Mostrador recepción de madera y metal efecto espejo
Reception desk in wood and metal with mirror effect

u.m.vta: 1  1

REF.03935

Con compartimentos interiores de madera para almacenaje y repisa
 With a shelf and interior wooden compartments for storage



Sofa espera 3 plazas
3 seater waiting sofa

u.m.vta: 1  1

REF.03950



En polipiel
 In black imitation leather

Recepción EARTH Reception EARTH

u.m.vta: 1  1

Grafito · Graphite

Blanco · White

Roble · Oak



REF.04518/50

REF.04518/58

REF.04518/65

- Laminado en grafito
- Con estantes regulables y 1 cajón

- Laminated in graphite
- With adjustable shelves and 1 drawer



Rollo 100 protectores silla

Roll 100 chair protectors

u.m.vta: 1  1

REF.07239



SCAN
ME!

- Mantenga los gérmenes alejados de sus asientos. Desinfección rápida y fácil: en cuestión de segundos, retire la funda del asiento y deseche. Se adapta a la mayoría de las sillas con respaldo.
- 65+16 x 150 cm / 0,025 mm
- Keep germs away from your chairs. Quick and easy disinfection: Remove the seat cover and dispose of it in a matter of seconds. It fits most chairs with a backrest.
- 65+16 x 150 cm / 0.025 mm



Contenedor toallas
Towels container

u.m.vta: 1  4

REF.03159



- Con ruedas
- Bolsa contenedora lavable
- Estructura de acero inoxidable
- Features wheels
- Washable containing bag
- Stainless steel structure

Organizador para colgar toallas
Organizer to hang towels

u.m.vta: 1  6

REF.04378



Ducha con soporte
Shower tap with support

u.m.vta: 1  20

REF.03004



Juego ducha adaptable
Shower adaptable

u.m.vta: 1  10

REF.01960



Monomando para lavacabezas
Mix taper for wash basin

u.m.vta: 1  50

REF.02837



Cabezal ducha iónico
Ionic shower head

u.m.vta: 1  36

REF.03750

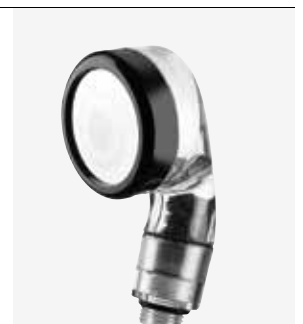

Ahorro agua
Mejor calidad de agua

Saving water
Better water quality

Conjunto monomando y ducha para lavacabezas
Single-lever mixer and shower for wash basin

u.m.vta: 1  12

REF.07618

NEW



Ducha con soporte lavacabezas
Shower with wash basin support

u.m.vta: 1  12

REF.07619

NEW



Cabezal de ducha cromado
Chrome shower head

u.m.vta: 1  12

REF.07620

NEW



Ducha lavacabezas negro
Black shower wash basin

u.m.vta: 1  12

REF.07625

NEW



Válvula fregadero lavacabezas
Wash basin sink valve

u.m.vta: 1  12

REF.07626

NEW



Reductor de flujo de agua
Water flow reducer

u.m.vta: 1  12

REF.07623

NEW



Tubo desague lavacabezas hasta 80 cm
Wash basin drain pipe up to 80 cm

u.m.vta: 1  12

REF.07624

NEW



Tubo flexible pvc ducha 120 cm para lavacabezas
PVC flexible shower hose for wash basin

u.m.vta: 1  12

REF.07621

NEW



Tubo flexible nylon ducha para lavacabezas
Flexible nylon shower tube for wash basin

u.m.vta: 1  12

REF.07781

NEW





08

Accesorios Accessories



*Papel protector, vestuario barbería,
pulverizadores, maletas, higiene...*

*Protector paper, barber clothing,
sprayers, suitcases, hygiene...*

El papel de cuello es un clásico en la barbería para evitar el picor en el cuello y que se puedan colar pelitos dentro de la ropa.
The paper of neck is a classic in the barbershop to avoid the itching in the neck and that hairs can be strained inside the clothes.

Pack 5 rollos papel de cuello kraft Pack of 5 rolls of kraft neck paper

RAGNAR
BARBER LINE

u.m.vta: 20	 20	 5
-------------	--	---

REF. 07445

- 80 servicios
- Tacto similar a la tela
- Gran absorción a los líquidos
- Transpirable y resistente a la humedad
- Garantía absoluta de higiene para sus clientes
- Materia prima procedente de bosques repoblados y controlados
- Waterproof

- 80 services
- Fabric-like feel
- High liquid absorption
- Breathable and moisture-resistant
- Absolute guarantee of hygiene for your customers
- Raw material from reforested and controlled forests
- Waterproof

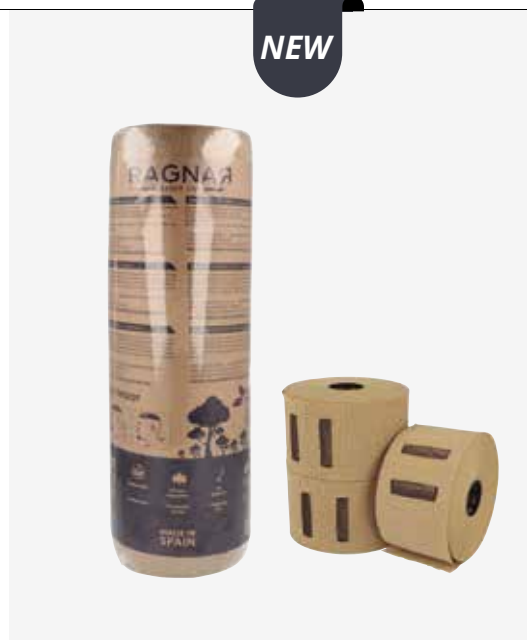

Sin crueldad animal
Animal cruelty free



Sin químicos
Chemical free



Bosques sostenibles
Sustainable forestry





Compostable
Compostable



Producto natural
Natural product

Pack 5 rollos de papel de cuello Barber Line Pack 5 rolls Barber Line neck wrap paper

Barber Line

u.m.vta: 6	 6	 5
------------	---	---

REF. 04651

- 100 servicios
- Blanca
- Cola negra

- 100 services
- White
- Black glue

Pack 5 rollos papel de cuello especial barbería, cola negra.
Packaging pre-cortado.



Pack 5 rolls special barber neck paper, black line. Pre-cut packaging.



Pack 5 rollos de papel de cuello Barber Line

Pack 5 rolls Barber Line neck wrap paper



Barber Line

u.m.vta: 6  6 

REF. 06596



SCAN
ME!

u.m.vta: 20  20 

REF. 06927



- 80 servicios
- Negro
- Cola blanca



- 80 services
- Black
- White glue

Papel de cuello negro reciclado, que no destiñe, no tiene cloro, por lo que podría usarse para uso alimentario (certificado ISEGA). Asimismo, consta del certificado FSC (de material procedente de bosques controlados) y PEFC (gestión sostenible de bosques).

Recycled black neck paper, which does not bleach, has no chlorine, so it could be used for food use (ISEGA certificate). It also consists of the FSC certificate (of material from controlled forests) and PEFC (sustainable forest management).

Rollo papel cuello

Neck wrap paper

u.m.vta: 100  100 

REF. 00681

- Cola azul de fácil pegado y colocación
 - Calidad premium
 - Ajuste perfecto y rápido
 - Higiénico de 1 solo uso
 - Papel desechable
 - Elástico ajustable a cada cuello
 - Diseñado para peluquerías y barberías profesionales
 - Evita picores y escozores en el cuello
- Blue glue for easy gluing and placement
 - Premium quality
 - Perfect and fast adjustment
 - 1-use hygienic
 - Disposable paper
 - Adjustable elastic to each neck
 - Designed for hairdressers and professional barbershops
 - Avoid itching and stinging in the neck



Separadores para el cabello

Separators hair

u.m.vta: 1  50 

Bolsa de 2 separadores. Velcro
Bag with 2 separators. Velcro

REF.06440

REF.06613



06440





06613



Portarollos para papel de cuello

Dispenser neck paper

u.m.vta: 1  6 



REF. 00800

- Para ref. 00681, 04651, 06596, 07445 y 06927
- For ref. 00681, 04651, 06596, 07445 and 06927



Portarollos para papel de cuello

Dispenser neck paper

u.m.vta: 1  4 



REF. 06803

- Material: ABS negro
- Se puede colgar en pared y espejo
- Para todo tipo de papel de cuello
- Material: Black ABS
- Can be hung on wall and mirror
- All kinds of neck paper



Bolsa de 50 protectores de ojos

Bag of 50 Barber Line protective eye masks

u.m.vta: 1  50 

REF. 06315



Protector orejas 50 unidades

Ear hood 50 units

u.m.vta: 1  50



REF. 07008

- Dimensiones: 2*4,5 cm
- Peso: 0,40 gramos
- Material plástico

- Dimensions 2*4.5 cm
- Weight 0.4g
- Plastic ear hood



Peinador silicona Silicone hairdressing gown



u.m.vta: 1  10 

REF. 07006



Capa de corte BARBER LINE BARBER LINE cutting cape



u.m.vta: 1  40 

REF.06988

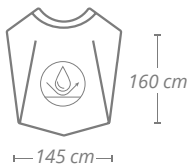

- Pongee polyester
- Repelente al agua
- Peso 150 gr
- Cierre botón

- Polyester pongee
- Water repellent
- Weight 150 g
- Closure: button



Capa de corte EUROSTIL EUROSTIL cutting cape



u.m.vta: 1  40 

REF.06989

- Pongee polyester
- Repelente al agua
- Peso 150 g
- Cierre botón

- Polyester pongee
- Water repellent
- Weight 150g
- Closure: button

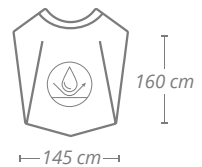

Capa de corte RAGNAR
RAGNAR cutting cape

RAGNAR
 BARBER LINE

u.m.vta: 1  40

NEW

American Old School
 REF. 07517



07517

Graffiti
 REF. 07518



07518

Aviator classic color
 REF. 07519



07519

Aviator classic
 REF. 07520



07520

Dolar american flag
 REF. 07521





07521



Cierre de gancho
 Hook closure



Capa rayas polo barber Polo barber cutting cape

u.m.vta: 1  40 

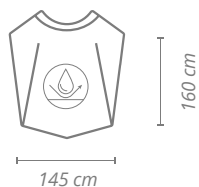
REF.06991



Capa rayas calavera skull cutting cape

u.m.vta: 1  40 

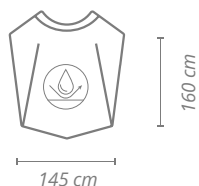

REF.06993



- Pongee polyester
- Repelente al agua
- Peso: 150 gramos
- Cierre: ganchos

- Polyester pongee
- Water repellent
- Weight 150 g
- Closure: hooks



Capa utensilios Utensils cape

u.m.vta: 1  40 

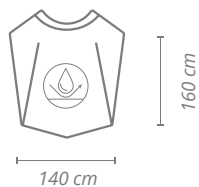
REF.06995



Capa rayas blancas negras Stripes cutting cape

u.m.vta: 1  40 

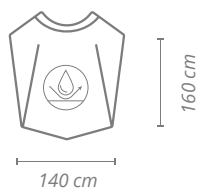

REF.06992



- Pongee polyester
- Repelente al agua
- Peso: 150 gramos
- Cierre botón

- Polyester pongee
- Water repellent
- Weight 150 g
- Closure: button

Capa barber shop Barber shop cutting cape

u.m.vta: 1  40 

REF.06997

- Pongee polyester
- Repelente al agua
- Peso: 150 gramos
- Cierre botón

- Polyester pongee
- Water repellent
- Weight 150g
- Button closure

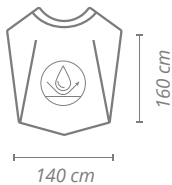

Capa de corte EUROSTIL EUROSTIL cutting cape

u.m.vta: 1  60

REF.04577

- Modelo calavera
- 100% nylon
- Cierre botón

- Skull model
- 100% nylon
- Button closure



Bolsa 30 capas negras Bag 30 black single use capes

u.m.vta: 1  50

Un solo uso
Single use

REF. 07243

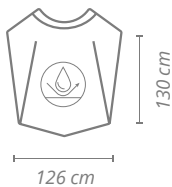

Capa de plástico para tinte Plastic-dye cape



u.m.vta: 1  12

Grande. Velcro
Grande. Velcro

REF. 01174





Delantal tejano con bolsillos Texan apron with pockets

u.m.vta: 1  10 

REF. 07010

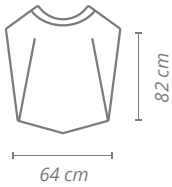
- Peso: 200 gramos
- Weight: 200 g





u.m.vta: 1  10 

REF. 07057

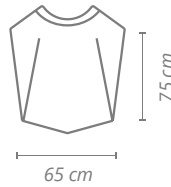
- Peso: 200 gramos
- Negro con detalles en símil piel
- Weight: 200 g
- Black with details in simulated leather.



Delantal tejano azul BARBER LINE BARBER LINE Apron Blue Jean



u.m.vta: 1  10 

REF. 07058

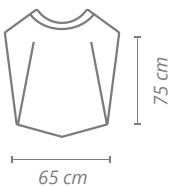
- Peso: 200 gramos
- Marcada con el logo Barber Line
- Weight: 200 g
- With hot stamping letters of Barber Line on the leather



Delantal BARBER LINE BARBER LINE apron

u.m.vta: 1  60 

REF. 06182

- 3 bolsillos, 1 superior, 2 inferiores
- 6 complementos, 1 superior y 5 inferiores
- 3 pockets, 1 upper, 2 lower
- 6 complements, 1 upper and 5 lower

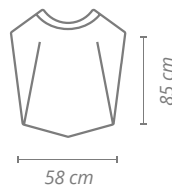



Capa de corte CAPTAIN COOK

CAPTAIN COOK cutting cape

u.m.vta: 1  12

100% Nylon
100% Nylon

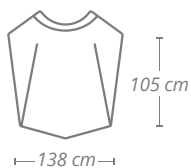

 **REF.04975/50**

 **REF.04975/58**



Delantal CAPTAIN COOK

CAPTAIN COOK apron

u.m.vta: 1  60 

3 bolsillos, 1 superior, 2 inferiores
6 complementos, 1 superior y 5 inferiores
3 pockets, 1 upper, 2 lower
6 complements, 1 upper and 5 lower

REF. 06181

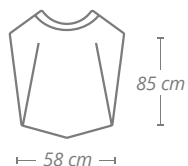

Capa de rayas barbero

Striped barber cape

u.m.vta: 1  40

MOD. 21800976

REF. 06351

lacla

Capa de polo barbero

Pole barber cape

u.m.vta: 1  40

MOD. 21800974

REF.06353



Capa camuflaje gris

Gray camouflage cape

u.m.vta: 1  40

MOD. 21800975

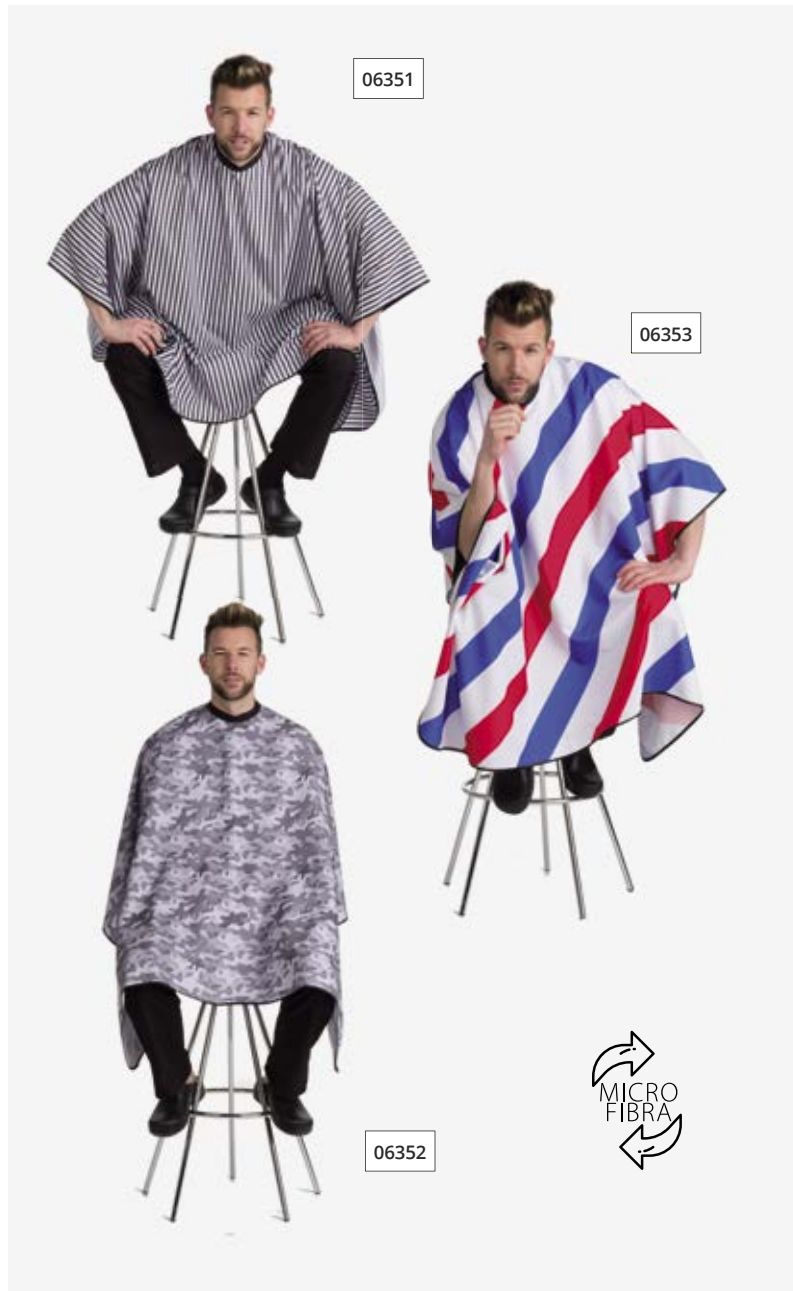
REF.06352

Ancho
WidthLargo
Long131/132 cm 
143/144 cm 

- 100% poliéster fino
- Con cierre de corchetes a presión
- Fácil de planchar
- Antideco y antiestática
- Talla única

- 100% fine polyester
- With clasps of pressure brackets
- Easy to iron
- Antideco and antistatic
- One size

Casaca cuello mao
Mao neck jacket



u.m.vta: 1 40

MOD. 51805305

REF.06357/50/3

L

- 118-122 cm
- 120-124 cm
- 74-76 cm

■
Largo
Length

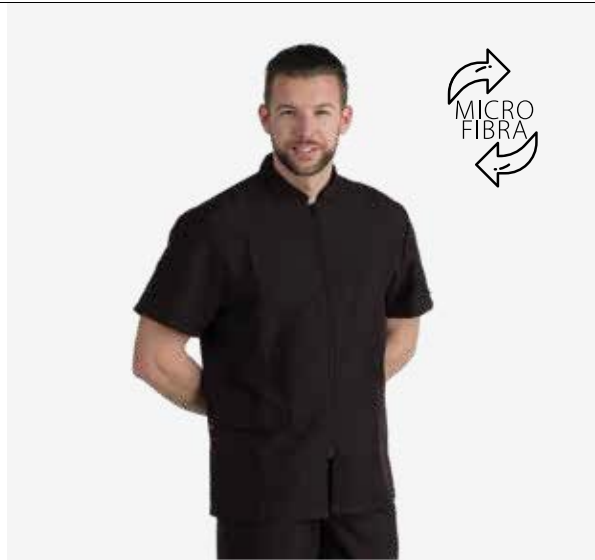

Casaca cuello mao con cremallera YKK. Tapabolsillos antipelo. Fácil de planchar. Antideco y antiestática. 100% poliéster fino

Mao collar with YKK zipper. Anti-ball cover. Easy to iron, antideco and antistatic. 100% fine polyester

Delantal polipiel
Leatherette apron

u.m.vta: 1 40

MOD. 31803151

REF.06350

- 28/29 cm
- 66/67 cm
- 81,50/82,50 cm

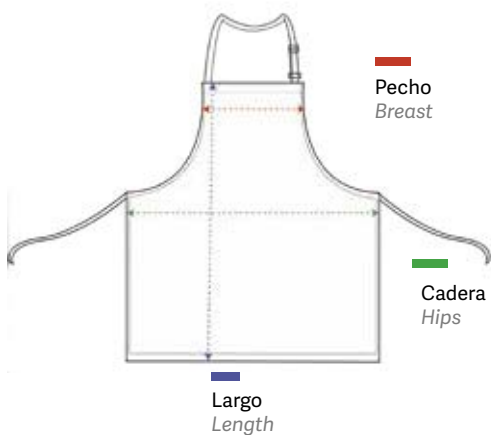

Delantal liso polipiel. Sin bolsillos. Impermeable. Con regulador en el cuello. Polipiel

Smooth leatherette apron. Without pockets. Raincoat. With regulator in the neck. Leatherette

Delantal retro tejano Retro denim apron

u.m.vta: 1  40

MOD. 31803155

REF.06355

 27/28 cm
 69/70 cm
 81/82 cm

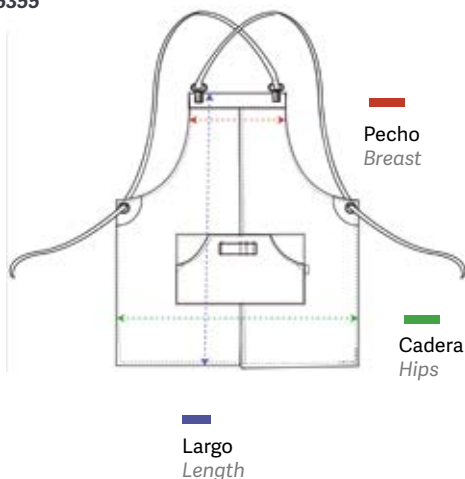

- Delantal retro tejano elástico con detalles en polipiel marrón. Bolsillo central con aplique para utensilios. Pinzas reguladoras cruzadas en la espalda. Corte central. Talla única
- 60% poliéster, 37% algodón, 3% elástico



- Retro elastic denim apron with brown faux leather details. Central pocket with utensil appliqué. Regulatory clamps crossed in the back. Central cut. Only size
- 60% polyester, 37% cotton, 3% elastic

Delantal peto tejano Denim bib apron

u.m.vta: 1  40

MOD. 31603125

REF. 06310/50

 25/26 cm
 82/83 cm
 81,50/82,50 cm

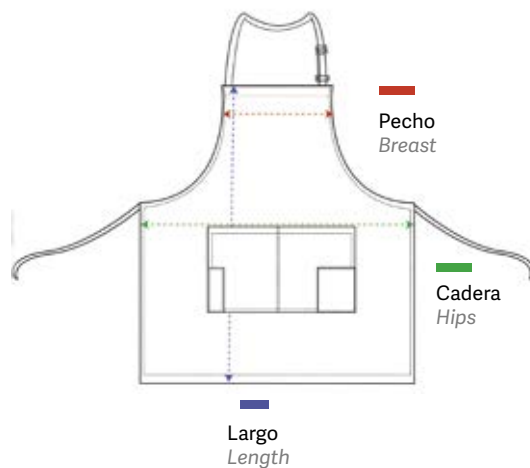

- Delantal y peto de tejano elástico. Regulación con correa y cierre lazo. Con 4 bolsillos (bolsillo central dividido en 2 + 2 pequeños). Talla única
- 60% poliéster, 37% algodón, 3% elástico

- Elastic denim bib apron. Regulation with strap and loop closure. With 4 pockets (central pocket divided into 2 + 2 small). Only size
- 60% polyester, 37% cotton, 3% elastic

Pantalón unisex
Unisex pants



u.m.vta: 1  40

MOD. 41300904





- Pantalón poliéster fino con 3 bolsillos. Ajustable a cintura con cordón. Fácil de planchar. Antideco y antiestático.
- 100% poliéster fino
- *Fine polyester pants with 3 pockets. Adjustable waist with drawstring. Easy to iron. Antideco and antistatic.*
- 100% fine polyester

S

-  96-96 cm
-  92-96cm
-  99-101 cm



REF.06356/1

M

-  102-106 cm
-  104-108cm
-  107-109 cm



REF.06356/2

L

-  110-114 cm
-  110-114 cm
-  107-109 cm

REF.06356/3

XL

-  112-116cm
-  114-118 cm
-  108-110 cm

REF.06356/4

 **Largo**
Length

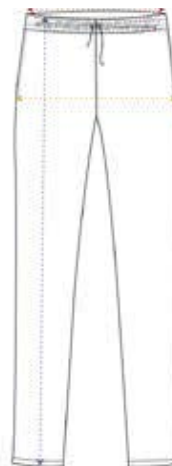

 **Cintura**
Waist

 **Cadera**
Hips



Spray barber Colores

Barber spray colours

u.m.vta: 1  10 

280 ml

REF.07000

- 6 ámbar + 3 transparentes + 3 grises
- Material: plástico
- Peso: 76 gramos

- 6 Amber + 3 clear transparent + 3 grey
- Material: plastic
- Weight: 76 g



07000





07002



Spray barber calaveras

Skulls spray barber

u.m.vta: 1  10 

500 ml

REF.07002

- Con pulverizador japonés
- Material: plástico
- Peso: 101 gramos
- 6 ámbar + 6 negras

- With japanese trigger
- 6 amber + 6 black
- Material: plastic
- Weight: 101g

06998



25 cm

6,5 cm

06999





24,5 cm

7,5 cm

Spray barber utensilios colores

Barber spray utensils colors

u.m.vta: 1  10 

500 ml

REF.06998

- 6 ámbar + 3 transparentes + 3 grises
- Material: plástico
- Peso: 76 gramos

- 6 amber + 3 clear transparent + 3 grey
- Material: plastic
- Weight: 76 g



Spray barber colores

Barber spray colors



u.m.vta: 1  10 

650 ml

REF.06999

- 6 ámbar + 3 transparentes + 3 grises
- Material: plástico
- Peso: 86 gramos

- 6 amber + 3 clear transparent + 3 grey
- Material: plastic
- Weight: 86 g



Pulverizadores EUROSTIL**EUROSTIL sprayer**u.m.vta: 1  20 

30 ml

REF.07001

- Botella transparente con pulverizador negro
- Material: plástico
- Peso 45 gramos

- *Transparent bottle + black trigger*
- *Plastic*
- *Weight 45g*

**Pulverizador****Sprayer**u.m.vta: 1  12 

300 ml

REF.04731

Spray continuo: con una sola presión pulveriza el agua de manera fina y uniforme con la misma presión desde el inicio hasta la última gota

360°: se puede usar desde todos los ángulos, incluso boca abajo

Pulverización fina, tipo niebla que distribuye el agua de manera uniforme sobre todo el cabello

Capacidad: 300 ml rellenable

Volúmen fijo de presión: 1,25 cc continuo

Evita la fatiga de la mano en comparación con los sprays estándar

Sin gases contaminantes



300 ml

REF.04978

Continuous spray: with a single press, the trigger sprays water in a fine, uniform mist with the same pressure from the first to the last drop

360°: can be used from all angles, even upside down

Fine mist spray that spreads water evenly throughout the hair

Capacity: 300 ml, can be refilled

Fixed pressure volume: 1.25 cc, continuous

Prevents hand fatigue compared to standard sprays

Does not contain polluting gases

RAGNAR
BARBER LINE

300 ml



REF.06243



Pulverizadores Barber Line

Barber Line sprayers

Barber Line



u.m.vta: 1  35 

Aluminio
Aluminium

280 ml

REF.04837



u.m.vta: 1  12 

Talco
Talc



180 ml

REF.06118



Pulverizador clásico talco BARBER LINE

BARBER LINE talc classic sprayer

u.m.vta: 1  12 

180 ml

REF.06179





u.m.vta: 1  12

180 ml

REF.06178



Pulverizador aluminio
Aluminium sprayer

u.m.vta: 1  35 

Interior lacado Neutro
Lacquered inside *Unprinted*

280 ml

280 ml

REF.01384

REF.01384/02



Expositor 30 pulverizadores aluminio
Display 30 aluminium sprayers

u.m.vta: 1  1

Eurostil Neutro
Eurostil *Unprinted*



280 ml

280 ml

REF.01465

REF.01465/02



Pulverizador plástico
Plastic sprayer

u.m.vta: 1  180 

Con colgador
With hanger

130 ml

REF.03401

u.m.vta: 1  24 

Negro japonés
Black japanese

300 ml

REF.04377



Mochila - Maleta para barberos

Bag - suitcase for barbers

u.m.vta: 1  4

REF.06797



- 4 compartimentos grandes con cierre de cremallera
- Dispone de más compartimentos interiores especiales para máquinas y utensilios
- Material: poliéster símil piel
- Cierre en las asas con clip

- 4 large compartments with zip closure
- It has more special interior compartments for machines and utensils
- Material: simile leather polyester
- Clip on handles with clip



Maletín negro para barbero

Black barber suitcase

u.m.vta: 1  12

REF.06438



Maleta trolley de polipiel para peluquería (vacía)

Leatherette trolley suitcase hairdressing (empty)

Todas las maletas se venden vacías
All the cases sold empty

u.m.vta: 1  1

REF.04308



REF.06136



- 3 compartimentos amplios con 2 bandejas en la parte superior con huecos para poner utensilios
- 4 ruedas para poder trasladarlo de forma cómoda y fácil
- Con ruedas extraíbles

- 3 large compartments with 2 trays at the top with holes for utensils
- 4 wheels for easy moving
- With removable wheels

Maleta trolley 4 cuerpos
4 section trolley suitcase

u.m.vta: 1  1

REF.04943

Maleta doble de nylon con ruedas. La maleta superior se puede convertir en maleta de mano, que viene con una tira para colgar del hombro. Tiene dos bandejas interiores las cuales pueden ser desplazadas hacia los laterales. El interior es amplio y la parte inferior es extraíble y está plastificada para facilitar la limpieza de la maleta. También en la parte trasera tiene un bolsillo exterior.

La maleta inferior, con ruedas, tiene la parte interior plastificada y es extraíble para facilitar la limpieza. Viene con una manta porta pinceles que está pegada mediante un velcro. Esta manta se puede intercambiar entre la maleta superior e inferior. Tiene 8 cajones para guardar y separar pequeños productos y un bolsillo en cada lateral. Cada columna integra 4 cajones extraíbles que van unidos en una sola pieza.

Nylon double suitcase with wheels. The upper case can be turned into a hand luggage, it has a strip to hold it in the shoulder. It has two interior trays that can be moved to both sides. The inside part is wide and the bottom is laminate and removable so the cleaning process its easier. In addition, there is a pocket in the back. The case below has wheels and the interior part is laminated and removable so and is removable so it's easier too clean. It includes a bag to keep make up brushes stucked with velcro. This bag can be exchanged between the top and the bottom suitcase. It has 8 boxes to keep and separate small products. It has a pocket on each side. Each side has a pocket and each column integrates 4 removable drawers that are joined in one piece.



Bolsa de peluquería con ruedas
Hairdressing handbag with wheels

u.m.vta: 1  1

REF.04402/50



- Con estructura metálica que permite usar la maleta como asiento
- With metal structure that allows to use the suitcase as a seat

Maleta trolley
Trolley

u.m.vta: 1  1

REF.03814/50



Maleta de aluminio peluquería
Aluminium suitcase hairdressing

u.m.vta: 1  1



REF.04307



(Vacía)
 (Empty)

Bolsa de 75 Toallas CELULOSA

Bag with 75 CELLULOSE towels

u.m.vta: 1  16 

50 g/m²

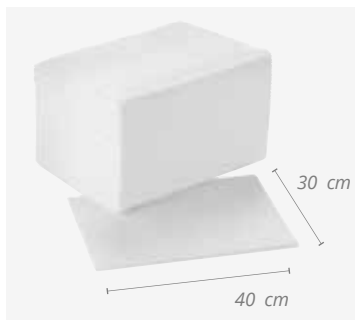

- Especial manicura
- Special manicure

REF. 04204



Bolsa de 25 toallas SPUNLACE



Bag 25 SPUNLACE towels

u.m.vta: 1  24 

50 g/m²

40 x 90 cm

REF. 04916

u.m.vta: 1  28 

50 g/m²

40 x 80 cm

REF. 03221



- Dobladas a 20 x 20 cm
- 50% poliéster / 50% viscosa

- Bent to 20 x 20 cm
- 50% polyester / 50% viscose



Bolsa de 90 toallas CELULOSA

Bag with 90 CELLULOSE towels

u.m.vta: 4  144 



55 g/m²

REF.04076



Bolsa de 100 toallas SPUNLACE

Bag with 100 SPUNLACE towels

u.m.vta: 4  20 

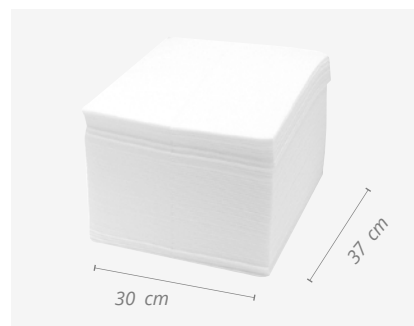

REF. 03283

- Súper absorbentes
- Super absorbent towels



Bolsa 25 toallas SPUNLACE

Bag 25 SPUNLACE towels

u.m.vta: 1  28 

50 g/m²



REF. 07233

- Súper absorbentes
- Super absorbent



35 toallas SPUNLACE

35 SPUNLACE towels

u.m.vta: 1  12 

50 g/m²



REF. 04509

- Súper absorbentes
- Toallas dobladas

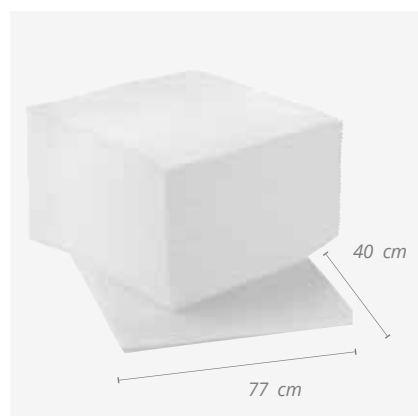
- Super absorbent
- Bent towels



Toalla 100% algodón
100% cotton towel

u.m.vta: 12  48 

380 g/m²

REF. 02947/50



REF. 04953/50

- Resistente lejía
- Resistant bleach



380 g/m²

REF. 02901/50





380 g/m²

REF. 06829/50

- Resistente a la lejía
- Resistant bleach



Toalla barbería 100% algodón
100% cotton barber towel

u.m.vta: 12  48 



380 g/m²

REF. 06413/50



100 Guantes de un solo uso para una higiene impecable

100 Disposable gloves for impeccable hygiene

u.m.vta: 1  25 

REF. 07257

- Ambidiestro permite usar cada guante para cualquier mano
 - Talla única
 - Multiuso
- *Ambidextrous allows each glove to be used for any hand.*
 - *One size*
 - *Multipurpose*



100 Guantes polietileno transparente

100 Transparent polyethylene gloves

u.m.vta: 100  100

REF. 07804

- 100% Polietileno virgen hdpe 0,7+/-2% g/pc
 - Hipoalergénicos
 - Impermeables
 - Talla única
 - Epi categoría 1
 - Confeccionado y marcado CE
 - Compatible con uso alimentario 2011/10/CE
 - 30 cm. alto x 25 cm. ancho dedos x 15 cm. ancho muñeca
- *100% Hdpe virgin polyethylene 0,7 +/- 2% g/pc*
 - *Hypoallergenic*
 - *Unpermeable*
 - *One size*
 - *Category epi 1*
 - *CE made & marked*
 - *Compatible with food use 2011/10/CE*
 - *30 cm. high x 25 cm. width between fingers x 15 cm width wrist*



Bolsa 100 guantes desechables

Bag 100 disposable gloves

u.m.vta: 1  100 

REF. 07304



Caja 20 guantes de látex negros
Box 20 black latex gloves

LÁTEX / LATEX
 AQL 1,5

u.m.vta: 1  24 

S

REF. 02832

M

REF. 02833

L

REF. 02834

Cumple normativa /
 Regulatory compliance: EN 374-1,
 EN 374-2, EN 374-3, CE



SIN polvo
 Powder FREE



Caja 100 guantes nitrilo negros
Box 100 black nitrile gloves

NITRILO / NITRILE
 AQL 1,5

u.m.vta: 1  10 

S

REF. 06686

M

REF. 06687

L

REF. 06688

Cumple normativa /
 Regulatory compliance: EN 374-1, EN 374-2, EN 374-3, CE



SIN polvo
 Powder FREE



Expositor tijeras metacrilato
Methacrylate display scissors

u.m.vta: 1  20

REF.04074



Contenedor para tijeras
Scissors container

u.m.vta: 1  24

REF.04740



Tarjetero aluminio
Aluminium card case

u.m.vta: 1  400

REF.02470



Cinturón porta útiles para cintura
Waist belt holder

u.m.vta: 1  48

REF.04310



Todos los porta útiles se venden vacíos
 All the purses for tools sold empty

Estuche utilaje porta útiles

Case tool holder

u.m.vta: 1  48

REF.03622 Con 5 combinables (vacío)
With 5 pockets (empty)

u.m.vta: 1  48

REF.03620

u.m.vta: 1  48

REF.03621



CAPTAIN COOK

CAPTAIN COOK

u.m.vta: 1  48

Estuche utilaje
Case tool holder

REF.04979

u.m.vta: 1  50

Gorra negra
Black cap

REF.07430

u.m.vta: 1  1

Camiseta negra
Black t-shirt

S

REF.04957/4

M

REF.04957/1

L



REF.04957/2





XL

REF.04957/3





Solución hidro-alcohólica
Sanitising solution

u.m.vta: 1		63		u.m.vta: 1		23
100 ml				500 ml		
REF.07176				REF.07177		

u.m.vta: 1		7		u.m.vta: 1		7	
1 L				Con dosificador With dosing pomp			
REF.07260				1 L	REF.07214		



Gel hidro-alcohólico con Aloe Vera
Sanitising gel with Aloe Vera

u.m.vta: 1		40	
100 ml			
REF.07246			





Gel hidro-alcoholico
Sanitising gel

u.m.vta: 1		22	
500 ml			
REF.07216			



Alcohol 96°
Alcohol 96°

u.m.vta: 1		12	
1 L			
REF.07218			



Artículos de venta exclusiva EN ESPAÑA
Those product are sold exclusively IN SPAIN



Antiséptico daromix GH
Daromix GH antiseptic

u.m.vta: 1  12

1 L

REF.06200

Desinfectante Limoseptol
Limoseptol disinfectant

u.m.vta: 1  20 

50 ml

REF. 06151

u.m.vta: 1  20

1 L

REF.06150





- N° Registro AEMPS: 905-DE5
- Antiséptico hidroalcohólico para desinfección higiénica de manos por fricción
- Eficacia garantizada científicamente
- Amplio espectro biocida a partir de 30 seg
- Fórmula hipoalérgica
- Preserva la hidratación de la piel
- No irritante cutáneo
- Seca rápidamente
- Eficaz como: bactericida, levuricida, virucida, microbactericida

- Registration Number AEMPS: 905-DE5
- Water alcohol antiseptic for hygienic friction disinfection
- Scientific efficiency guaranteed
- Wide biocide range from 30 sec
- Hypoallergenic formula
- Preservs skin hydration
- No skin irritation
- Quick drying
- Effective as: bactericide, levuricide, virucidal and microbactericide

- Dosis: 100 ml en 10 l de agua
- Tiempo: 15 min
- N° Registro AEMPS: 47-DE5
- Producto de gran alto nivel desarrollado exclusivamente para la higiene, limpieza y desinfección, de utensilios profesionales de salones de belleza
- Acción detergente - Amplio espectro
- Biodegradable - Sin fosfatos y SIN FORMOL
- Eficacia germicida y DESINFECTANTE frente a: bacterias, levaduras y hongos

- Dosage: 100 ml in 10 l of water
- Time: 15 min
- Registration Number AEMPS: 47-DE5
- High level product developed exclusively for the hygiene, cleaning and disinfection, for professional utensils of salons of beauty
- Detergent action - Wide spectrum
- Biodegradable - No phosphates/formol
- Disinfectant and germicide efficiency against bacteria, yeast and fungi

Botella especial para gel y solución hidroalcohólica
Special bottle for gel and sanitising solution

u.m.vta: 1  3 



Con soporte para pared
 With wall bracket

300 ml

REF.07278



Frasco esterilizador grande
Large sterilizer bottle

u.m.vta: 1  6 

1 L



REF.06141



- Ideal para esterilizar pequeños utensilios
- Material: vidrio

- Ideal for sterilizing little tools
- Material: glass



Espejos Mirrors

u.m.vta: 1  10 

Espejo negro
Black mirror

●
REF. 02591/50





u.m.vta: 1  10 

Espejo TV
TV mirror

●
REF. 00254/50



u.m.vta: 1  6 

REF. 01955/50 Espejo profesional con asas negro
Professional black mirror with handles



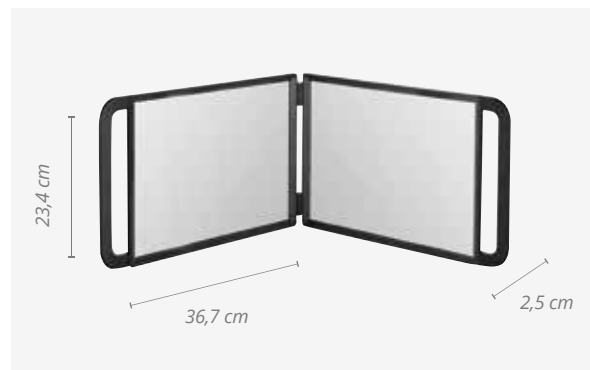

u.m.vta: 1  12

REF.04379 Espejo doble profesional
Double professional mirror



Espejo de espuma EVA con asa negro
Black EVA foam mirror with handle

u.m.vta: 1  10 

REF. 02170



Alfombra desinfectante de calzado
Shoe disinfectant mat

u.m.vta: 1  12

REF.07234

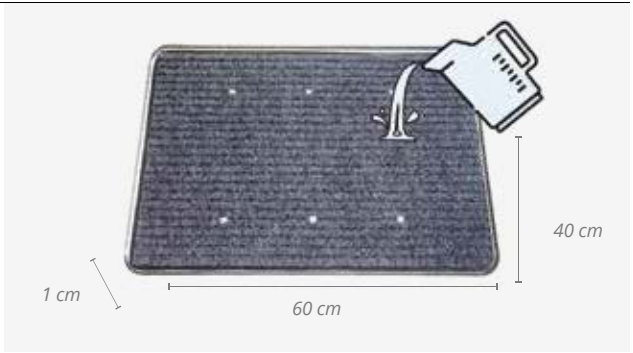



Alfombra extraplana de solo 1cm de alto para evitar tropiezos fabricada en polipropileno sobre una base de caucho y contenedor de aluminio ionizado. Medidas: 60 cm de ancho x 40 cm de largo x 1cm de alto/grosor.

Extra flat mat. Only 1cm high to avoid tripping. Made of polypropylene on a rubber base and ionised aluminium container. Measurements: 60 cm wide x 40 cm deep x 1 cm high/thick

Modo de uso: colocar la alfombra sobre una superficie plana y nivelada aplicar en la bandeja unos 700ml aproximadamente de líquido desinfectante. Se aconseja colocar un felpudo después de la bandeja para secar el calzado del cliente.

Instructions for use: Place the carpet on a flat, level surface and apply approximately 700 ml of disinfectant liquid to the tray. Place a mat after the tray to dry the customer's shoes.

Gafa protectora antivaho
Anti-fog protective goggles

u.m.vta: 1  10 

REF.07256



- Protección para prevenir infecciones: protegen eficazmente de las salpicaduras, grava, etc.
- Lugar de uso: cualquier lugar donde se requiere protección para los ojos.
- Diseño innovador cómodo. Se ajustan perfectamente a cualquier forma y tamaño de cabeza. Se pueden utilizar al mismo tiempo que sus gafas graduadas.
- Certificado CE
- Material: plástico

- Protection to prevent infection: They effectively protect from splashing, gravel, etc.
- Place of use: any place where eye protection is required.
- Innovative and comfortable design. They fit any shape and size head perfectly.
- They can be used with your prescription glasses.
- CE-certified
- Material: plastic

Bolsa 100 peucos cubrezapatos
Bag 100 shoe covers

u.m.vta: 1  50

REF.07211



Plástico. Un solo uso
Plastic. Disposable



Dispensador gel automático de pared con bandeja
Gel mounted automatic gel dispenser with tray

u.m.vta: 1  12

1 L

REF.07271



Dispensador gel automático de sobremesa
Desktop automatic gel dispenser

u.m.vta: 1  12

1 L

REF.07272



Dispensador gel automático de pared con pie
Floor standing automatic gel dispenser

u.m.vta: 1  12

1 L

REF.07273



Dispensador gel manual de pared
Manual wall dispenser

u.m.vta: 1  12

700 ml

REF.07274





Escobas de goma Rubber brooms

u.m.vta: 4  16

Con lengüeta
With thread

REF.01223



u.m.vta: 5  20 

REF. 01285/50



u.m.vta: 5  20

Rosca española e italiana
Spanish and Italian thread

REF.02420



- De fácil limpieza y de larga duración, la eficacia del diseño de sus púas logra arrastrar el polvo sin levantarlo, por lo que es ideal para personas alérgicas ya que favorecen a un ambiente limpio
- Easy to clean and long-lasting, the effectiveness of the design of its spikes manages to drag the dust without lifting it, making it ideal for allergy sufferers as they favor a clean environment

Mango para escoba Broom handle

Rosca española e italiana
Spanish and Italian thread

u.m.vta: 12  12

REF.01131

- De fácil limpieza y larga durabilidad
- Soporte de plástico
- Ideal para todo tipo de suelos, en especial el parquet

- Easy cleaning and long durability
- Plastic support
- Ideal for all types of floors, especially wood floor



u.m.vta: 10  10

REF.01365

- Telescópico extra
- Extra telescopic





09

Formación Training

*Maniquís hombre,
soportes, trípodes...*

*Men mannequin,
suports, tripods...*

EUROStil

PROFESIONAL

Maniquís hombre, CABELLO 100% NATURAL Men mannequin, 100% NATURAL HAIR

Con soporte incluido
With holder included



u.m.vta: 1 10 10

- 42 implantes por cm²
- 7-8 cabellos por implante
- 320 cabellos aprox por cm²
- Para corte, decoloración, coloración, peinado, secado y planchado
- Temperatura máxima 180°C

- 42 insertions per cm²
- 7-8 hairs per implant
- 320 hairs per cm²
- For cutting, bleaching, coloring, combing, drying and ironing
- 180°C maximum temperature

Castaño · Brown

REF. 02495

- Implantación natural 45°
- 45° natural insertion

Castaño con barba · Brown with beard

REF. 02169

- Implantación natural 45°
- También para corte barba
- 45° natural insertion
- Also for beard cutting



Maniqués hombre, CABELLO 100% NATURAL

Men mannequin, 100% NATURAL HAIR

u.m.vta: 1

10



- 42 implantes por cm²
- 7-8 cabellos por implante
- 320 cabellos aprox por cm²
- Para corte, decoloración, coloración, peinado, secado y planchado
- Temperatura máxima 180°C

- 42 insertions per cm²
- 7-8 hairs per implant
- 320 hairs per cm²
- For cutting, bleaching, coloring, combing, drying and ironing
- 180°C maximum temperature

Castaño claro · Light brown

Joe

REF. 06147

- Implantación natural 45°
- 45° natural insertion

**Joe**

REF. 04909

- Implantación clásica 90°
- 90° classic insertion



Castaño claro con barba · Light brown with beard

Daniel

REF. 06148

- Implantación natural 45°
- 45° natural insertion

**Daniel**

REF. 04908

- Implantación clásica 90°
- 90° classic insertion



Soportes cabeza maniquí
Mannequin head holders

u.m.vta: 1  25

REF. 00983





- Plástico
- Plastic

u.m.vta: 1  50

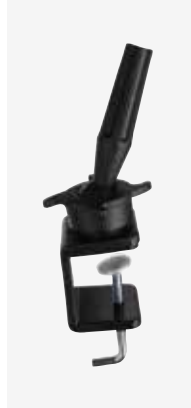
REF. 01461





- Plástico
- Plastic

u.m.vta: 1  100 

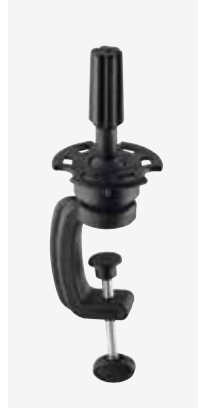
REF. 06276



- Plástico
- Plastic

u.m.vta: 1  10 

REF. 06162

9x10 units

- Plástico
- Plastic



u.m.vta: 1  12

REF. 03625

- Aluminio
- Aluminum



Soporte trípode cabeza maniquí de aluminio
Aluminum mannequin head tripod holder

u.m.vta: 1  10

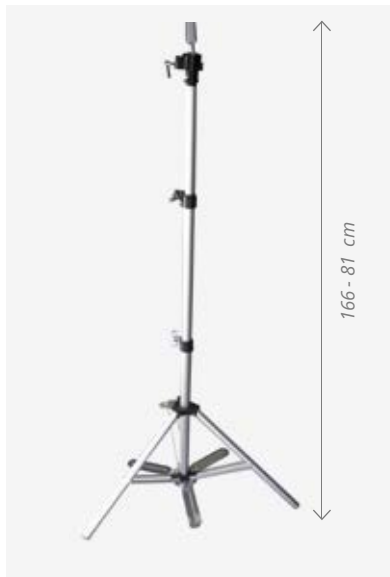

REF. 03738



u.m.vta: 1  6

REF. 03624



u.m.vta: 1  6 

REF. 01841







C/Ciudad de Asunción 56 · Barcelona 08030 (Spain)
Tel. +34 93 274 07 84
ventas@eurostil.com · export@eurostil.com